

elektor

INDIA

105

February 1984

up-to-date electronics for lab and leisure

Rs. 7.50

Srinivas Singh

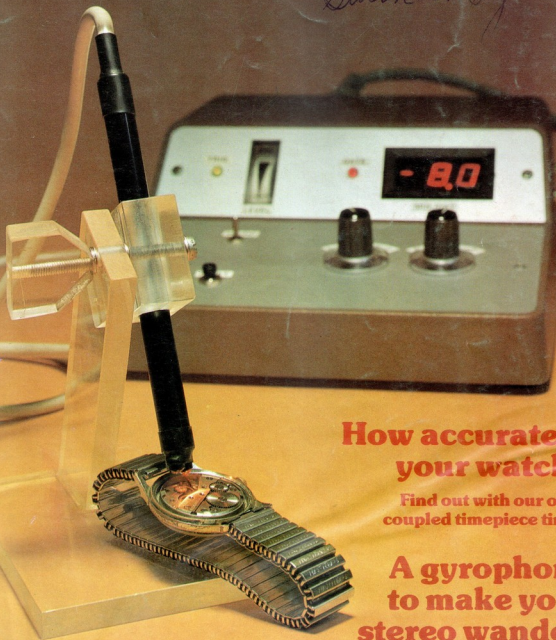

**How accurate is
your watch?**

Find out with our opto-
coupled timepiece timer.

**A gyrophone
to make your
stereo wander.**

PLUS : audio embellisher • address decoding • weather vane •
universal active filter • audio sleuth • Z80 EPROM programmer •
programmable crystal oscillator • digital cassette recording •

105

105

contents

gyrophone	2-14
With this unit connected to your stereo system you can produce an effect very like that of a Lesley rotating speaker system.	
how accurate is your watch?	2-16
'Clockwork' watches can be very accurate provided they are adjusted properly. The circuit described here quickly calculates the error in a mechanical ticker so that it can be set correctly.	
digital cassette recorder	2-23
Cassette tape is often used as memory storage in personal computers. Unfortunately, the quality of the computer's cassette interface usually leaves a lot to be desired. The present circuit improves matters considerably without affecting the audio performance of the cassette recorder.	
audio signal embellisher	2-28
A three part modular system that can increase your listening pleasure if you are forced to connect mono and stereo equipment together.	
universal active filter	2-36
An IC that can act as a universal active filter with a minimum of external components is certainly worth having a look at.	
from thermometer to thermostat	2-38
Adding a single IC and a handful of other components to the LCD thermometer featured in our October 1982 issue permits it to be used as a thermostat.	
audio sleuth at work	2-39
When something goes wrong (and it often does) this article can help you find the root of the problem.	
wind direction indicator	2-42
Many lament the passing of the weathercock, but our electronic version has at least one distinct advantage in that you no longer have to see the actual weather vane to know which direction the wind is blowing.	
Z80 EPROM programmer	2-50
A small circuit consisting of just a few components is all that is needed to enable any Z80 system to program 2716 EPROMs <i>in situ</i> .	
home-made low-cost wiring probe	2-52
Wiring prototype circuits is greatly simplified by keeping the wire tidily on a spool.	
address decoding	2-54
One of the least understood aspects of computing is address decoding. This article is intended to throw some light onto the subject.	
applicator	2-59
New programmable crystal oscillators in which the oscillator, dividers, and selector circuits are housed together with the quartz crystal in a 16-pin DIL package.	
market	2-61
missing link	2-65
EPS service	2-65
switchboard	2-67
advertisers index	2-74



Handwritten signatures:
S. J. ...
S. ...

Handwritten: FIRST INDIAN ISSUE

- A selection from next month's issue:**
- capacitance meter
 - video combiner
 - video syncbox
 - constant-light source
 - disco control unit
 - tachometer for diesels

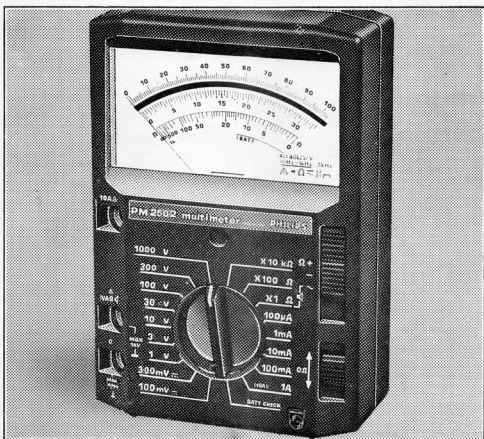

**PM 2502 Analogue multimeter.
Every feature you need at a down-to-earth price!**

The PM 2502 is a rugged, compact, general-purpose multi-meter with a 25 μ A tautband moving coil movement.

Another advanced Philips Multimeter: Autoranging, Digital Multi meter PP 9005.

For further details contact:

Philips India

Test & Measuring Instruments Division
Plot 80, Bhosari Industrial Estate
PUNE 411 026

**Test & Measuring
Instruments**



PHILIPS

Philips — the trusted Indian household name for over fifty years.

OBM/8686 R1



KELTRON
COMPONENTS
THE
ELECTRONICS
SUPERMARKET

Ceramic capacitors from the Keltron supermarket:

**KELTRON
COMPONENTS
THE
ELECTRONICS
SUPERMARKET**

Designed to withstand all climatic vicissitudes. With high insulation resistance, low dissipation factor, good dielectric strength and operating stability. In a range of voltages for both temperature compensating and high dielectric constant types.

Regd. Office : □ Kerala State Electronics Development Corporation Ltd., Keltron House, Vellayambalam, Trivandrum 695 001. Tel : 60621
Telex : 0884-273 KEDC IN Telegram : ELECTRONIC

Branch Offices : □ 102-A Poonam Chambers, Dr. Annie Besant Road, Worli, Bombay 400 018. Telephone : 893457, 397448 Telex : 011-5139 Telegram : KELTRONBOM □ 75-C Park Street, Calcutta 700 016. Telephone : 245654, 213200 Telex : 021-2207 Telegram : THYRISTOR □ Sudarshan Building, 86, Chamiers Road, Madras 600 018. Telephone : 442310 Telex : 041-7632 Telegram : KELMAD □ Hemkunt Towers, 2nd floor, Nehru Place, New Delhi 110 019. Telephone : 644692, 648493 Telex : 031-3774 Telegram : KELTRON □ Centenary Building, 28, M.G. Road, Bangalore 560 001. Telephone : 564492, 564528 Telex : 0845-746 Telegram : KELTRON □ Syrian Church Road, Near Spencer Junction, Trivandrum 695 010. Telephone : 60241 Telex : 0884-283 Telegram : ELECTRONIC □ 3-4-492, First floor, Barkatpura, Hyderabad 500 027. Telephone : 63786 Telegram : KELTRON □ 67, Pritamnagar, Mangaldas Road, Ellis Bridge, Ahmedabad 380 006. Telephone : 79867, 463664 Telegram : KELTRON.

TriKaya.KC.11.83

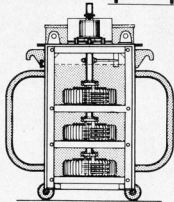
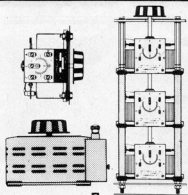
AE**ELECTRICAL MEASURING INSTRUMENTS
& POWER CONTROL EQUIPMENT****AE DIMMERSTAT®**

Continuously Variable Auto-Transformers are made since 1950, smallest model is for 0.75 Amp and largest is for 200 Amps. Manual & Motor operated operation.

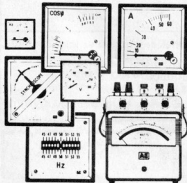

AE Leading manufacturer of Panel mounting & Portable Electrical Measuring Instruments, Moving Iron & Moving Coil type, Dynamometer type, Transducer operated type, for measurement of Voltage, Current, Power, Power Factor, Frequency.

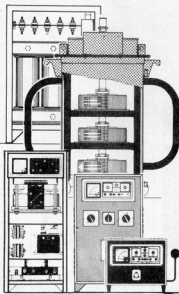

AE Line Voltage Stabilizers - First made in 1965 for protecting voltage sensitive Defence equipment, they are now used in Industry, where a stable voltage is necessary for efficient working. Single phase models for loads from 1 KVA to 250 KVA & 3 phase models from 5 to 1000 KVA are standard products.

Rectifiers for D.C. power required for electroplating & electro-chemical industry are in wide use. For Communication Equipment & Telephone exchanges, they are used as float chargers

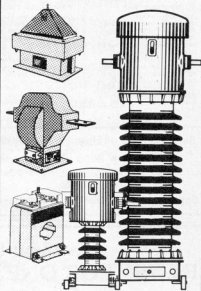

AE Instruments & Protective Transformers, for use on lines upto 220 KV, 22 KV. & Higher voltage CTs & PTs are oil filled and outdoor type, Lower voltage models are available as Resin-cast for indoor use. CT/PT measuring sets are made upto 22 KV.

**AE Automatic Electric Ltd.**

"RECTIFIER HOUSE" P.O. BOX NO. 7103, BOMBAY-400 031.
PHONE: 8829330-33 TLX.: 11-71546

back number service

elektor
40-48 NEW PROJECTS IN 100 PAGES No. 128

LCD digital thermometer
programmable
dark room timer
7 day time controller



E1, May 1983
 Low-power digital thermometer/ MC/ MM photo preamp/ technical answers/membrane switches/interlude/ RC equalizer/ 7-day timer/controller/ junior program-tester/ prelude (part 3)/ programmable dark room timer/ talking-clock extension.

elektor
40-48 NEW PROJECTS IN 100 PAGES No. 129

µP keyboard
with 4000 A/D converter
IR remote control



self-locking mouse decoder
to protect the
microcomputer

E2, June 1983
 Wattmeter/ ASC II keyboard/P.S. Multitester/Maestro (Part 1)/What is power?/ parallel serial keyboard converter/morse converter/ 78L voltage regulators and 79L/ morse decoding with the 250A.

elektor
40-48 NEW PROJECTS IN 100 PAGES No. 130

Spectrum Display
by conversion of a spectrum
Teletype decoder
hour meter
anal switch



E3, July 1983
 Energy meter/ switching channel for radio control/RTTY decoder/electronic aerial switch/spectrum display/maestro (Part 2)/video effect generator/ morse and radio teletype RTTY/ applicator.

elektor
40-48 NEW PROJECTS IN 100 PAGES No. 131

circuits special '83
more than 100
practical projects

E4 5, Aug/ Sept 1983
 Circuits special '83 more than 100-practical projects.

elektor
40-48 NEW PROJECTS IN 100 PAGES No. 132



E6, October 1983
 Video graphics/ audio test/ 64k on the 16k Dynamic CMOS/ VDU card/ high-speed CMOS/ VDU card/ personal FM/precision voltage divider/ Junior Synthesizer/ simple MOSFET tester/ the stamp.

elektor
40-48 NEW PROJECTS IN 100 PAGES No. 133



E7, November 1983
 Basicode-2/ music quantizer/ solid-state dark room lighting/ high-voltage regulator/ anemometer/programmable power supply/ Basicode-2 interface for the Junior Computer/ electronic voltage regulator/ battery eliminator/ transistor selector/ FSKleaver/ useful tip... 2N3055 super Darlington pair/ EPROMmer using the Junior Computer.

elektor
40-48 NEW PROJECTS IN 100 PAGES No. 134



E8, December 1983
 Doorbell - or telephone - operated flash light/ power controller for model railways/decoupling in digital circuits/CPU card/decimal-to-binary converter/movement detector/electronic two-tone metronome/ pseudo stereo/universal terminal/ultrasonic/infrared barrier/trick battery/power flasher.

elektor
40-48 NEW PROJECTS IN 100 PAGES No. 135



E9, January 1984
 64-way 2-dimensional bus board/ MP/HP USB marine receiver/ LED ornaments/ symmetrical power supply/ video amplifier/ frost warning device/ disco phaser/ banking program/ NO/VRAM/ data storage without batteries bus extension/ locomotive headlamp reverser applicator.

Back numbers of Elektor India currently available are detailed above, with a brief description of their contents.

- Send for your copies now • Price : Any one issue Rs. 7.50. • AUG/SEP Issue Rs. 15/-
- Price includes postage • Price subject to change without notice. • **NO V.P.P.**

PLEASE

Send payment to **Elektor Electronics Private Ltd.** 3 Chunam Lane, Dr. Bhadkamkar Marg, Bombay 400 007

Have you Subscribed to **elektor** INDIA
Rs. 75/- FOR ONE YEAR
Rs. 140/- FOR TWO YEARS AND
Rs. 200/- FOR THREE YEARS.
 Use the order card in this issue and ensure your copies.

INTRODUCING

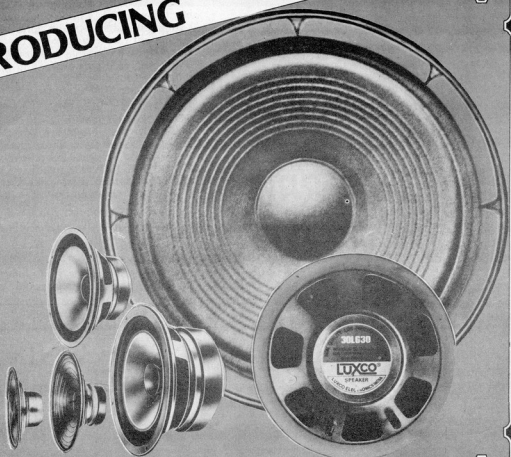

**12''
HIFI
SPEAKER**

**Now Available -
High Performance
Woofers &
Full Frequency Range**

The new 12'' speaker is yet another addition to Luxco's growing range of Hi Fi speakers. This speaker will complement the existing high performance luxco tweeters and midranges very well.

Manufactured by: **LUXCO Electronics**, Allahabad, Telex : 540-286

Sole Selling Agent: **LUXMI & CO.** 56, Johnstonganj, Allahabad 211 003. Phone : 54041

Distributors for Gujarat & South India:

precious[®] Electronics Corporation

3, Chunam Lane, D. Bhadkamkar Marg, Bombay 400 007. Phone : 367459/369478
9, Athipattan Street, Mount Road, Madras 600 002. Phone : 842718

Distributors for Delhi & Haryana:

Railton Electronics Radio Place, Chandni Chowk, Delhi 110 006. Phone : 239944/233187

Wanted Stockists all over India

COMPUTERS AND THE C.A.

Inaugurating a seminar on 'exposure of computers to chartered accountants', organised recently by the Computer Society of India (CSI), Delhi Chapter as part of their Computer Day Celebrations, the Union Minister for Steel and Mines, Mr. N.K.P. Salve, called upon chartered accountants to increasingly utilise computers in their work as auditors, tax executives or finance managers; he cautioned them, however, to make the machines work for them and not become their slaves. He also dwelt upon the advantages the computers could provide in inventory control and management.

Mr. N. Kohli, CSI secretary, observed that computers would have a major impact on the working of finance professionals, adding that computer facilities were now available at a considerably lower cost. **INDO-FRENCH TIE-UP**

By an agreement initialled at New Delhi, following a three-day meeting of Indo-French working groups on computer hardware, software and informations, India and France have agreed to collaborate in a host of frontline areas of computer technology and electronics. The main feature of the agreement is the vertical transfer of technology by France to India, covering super mini computers, computer peripherals, packaging technologies and sophisticated components, with buy-back arrangements in certain peripherals like floppy disc drives. Other areas covered by the agreement are joint development of a new multiprocessor architecture and super-micro-computer based on SM90, setting up of institution based on computerised instruction for training in software, computer networks and telematics, besides fifth generation computers. The Indian side was led by Dr.

N. Seshagiri, director (computer development), Department of Electronics and the French side by Mr. Christian Stoffaas, additional secretary, department of electronics and informatics in the French Ministry and Research.

ELECTRONICS COMPLEX IN GUJARAT

Gujarat State has ambitious plans to develop the electronic industry in the state and has offered several inducements to the industry to set up units in Gujarat Industrial Development Corporation's (GIDC) exclusive industrial estate

for electronics industry at Gandhinagar, 22 kms away from Ahmedabad. A few of the incentives are: cash subsidy up to Rs. 25 lakhs; sales tax exemption up to Rs. 80 lakhs or sales tax deferment up to Rs. 50 lakhs; a quasi equity, interest free loan ranging from 10-20% of the fixed capital investment or Rs. 7.5 crores (whichever is more) to large electronic units under LEEP. The Government has already reduced sales tax on electronic components and end products manufactured in the state. The Industrial Training Institute at Gandhinagar is conducting special courses in electronics, so as to provide the industry with a skilled workforce.

MICRO-COMPUTER PROJECT IN A.P.

A micro-computer project costing Rs. 12.50 lakhs will be set up by the Integrated Data Systems Pvt. Ltd., a company run by technocrats, and assisted by the Andhra Pradesh Electronic Development Corporation (APEDC), for which a promotional agreement has been signed. Products to be manufactured, like video terminals, data entry systems and word processors of 8 and 16 bit range, find application in business, banking, reservation and process control. The unit is expected to go into commercial production within three months.

BRIGHT FUTURE FOR ELECTRONICS

Inaugurating a seminar at Bombay on 'Growth of Electronic Components' organised by the Institution of Engineers with the Electronic Component Industries Association (ELCINA) and the Institute of Electronic and Telecommunication Engineers (ETE), Dr. P.P. Gupta, Electronics Secretary, said that he expected the output of electronic goods to touch Rs. 10,000 crores by 1990, of which the requirements of components would be in the order of Rs. 2000 crores. He pointed out that the electronics sector was open to all industries in that there were no restrictions on FERA, MRTP, joint or private sector companies. He added that the government is promoting the concept of independent test laboratories where comprehensive facilities are being established; these include various combinations of environmental severities, vibration, shock and other mechanical endurance test facilities with automated test equipment.

COMPUTER SYSTEM INSTALLED

A computer system has been installed in the Ministry of Wroks & Housing by the National Information Centre of the Electronics Commission, to facilitate its work and of its constituent departments and organisations. It is expected to streamline the working of the estate office, Central PWD and other units of the ministry handling data on a large scale. The National Information Centre (NIC) has installed an HP-1000 computer which has stand-alone capabilities. It is also connected to the computer cyber 170/720 system both through the P & T Lines and the VHF radio link, whereby the Ministry would be able to tap considerable computer resources from its location in Nirman Bhavan. The Ministry has also initiated a series of training courses for programmes organised by the NIC in collaboration with the National Buildings Organisation.

POLYSILICON PLANT

The Union Government has finalised agreements for the purchase of foreign know-how for setting up a plant to manufacture polysilicon, the substance used in the production of photo-voltaic cells and integrated circuits popularly called 'chips'. It is learnt that a negotiation committee constituted for working out technical collaboration agreements for the polysilicon plant and confirming it for investment approval, had had detailed discussions with leading polysilicon producers before finalising the agreements.

ELECTRONIC COMPLEX IN W.B.

The Government of West Bengal has initiated plans to develop the electronics industry in a big way. The committee on electronics, headed by the chief minister, Mr. Jyoti Basu, held its first meeting recently at Calcutta, when a number of points on the development of the industry was discussed. The agenda of the meeting also included the clearance for transferring 93 acres of land at Salt Lake to individual parties who will collectively form the electronics complex. Also discussed at the meeting was the perspective plan for development of electronics in the seventh plan. With a view to decentralising the growth of the industry in the state, officials and experts will visit Darjeeling, Jalpaiguri, Bankura and Durgapur to identify suitable locations.

Most of us have heard the stereo effect of an express train, a gale force wind, or perhaps an artificially created sound transferring from the right-hand to the left-hand speaker. It's just as impressive when the sound returns from the left-hand to the right-hand speaker, as when, for instance, a train from the opposite direction passes by. The circuit described in this article makes it possible for both effects to happen simultaneously: creating a sound very much like that of a Lesley rotating speaker system.

gyrophone...

. . . to make
your stereo
wander

Before we go any further, there is one thing to be borne in mind: the contents of the two stereo channels must be quite distinct from one another if the effect is to be realized. A short listening test will soon show which type of recording is suitable: listen to it and then turn one of the speakers off. If half of the sound just 'dies', the recording is usable. Stereo records produced ten years or more ago are particularly suitable.

The circuit is not really an electronic version of a Lesley because phase shifts are not catered for, but its action is none the less remarkable. Briefly, the right-hand signal 'wanders' to the left-hand channel, and vice versa. Shortly afterwards, the two sounds revert to their original channel. This effect is achieved by periodically inverting the two channels.

The block diagram in figure 1 shows that the signals from the two channels are split and applied to four operational transconductance amplifiers (OTAs). However, although both OTA1 and OTA3 are fed with the left-hand signal (and OTA2 and OTA4 with the right-hand signal), they are not controlled by the same sawtooth voltage. The low-frequency oscillator (LFO) drives OTAs 1 and 4 directly and OTAs 2 and 3 via an inverter. This means that OTAs fed with the

same stereo signal have opposing control signals. The left-hand information is therefore amplified in OTA1 but attenuated in OTA3 and consequently appears in the left-hand but not in the right-hand output. From time to time, however, the control signals are such that the left-hand information appears in the right-hand but not in the left-hand output. The right-hand input signal is treated in an identical manner. The whole process is continuous and therefore causes the characteristic swelling and fading of the loudspeaker outputs. In contrast to a real Lesley, our circuit creates the effect only by differences in volume in each individual channel.

A low-frequency oscillator consisting of integrator A1 and trigger A2 (see figure 2) generates a sawtooth voltage. This voltage should not go negative because that would block the OTAs, and a diode, D1, is therefore included in the feedback path of A2. The sawtooth voltage is fed to A3 and to inverter IC2. The output of IC2 is applied to the inverting input of A4. Opamps A3 and A4 drive transistors T1 and T2 and these in turn feed the four OTAs.

As already explained, the signals from the two channels are split and the parts are amplified in different OTAs. Output channel L contains a mixture of the signals

Figure 1. Block schematic of the gyrophone. The signal and control paths (the latter in dashed lines) are shown separately to clarify the operation of the gyrophone.

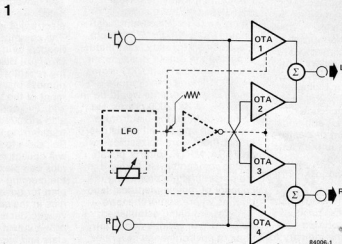

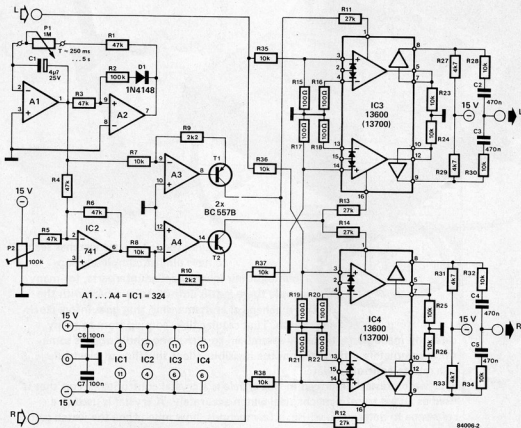

fed to OTAs 1 and 2 and, similarly, output channel R a mixture from OTAs 3 and 4. The mixing elements are formed by two resistors and a capacitor (for instance, R27/R28/C2).

The buffers contained in IC3 and IC4 (pins 7, 8 and 9, 10 respectively) must not be used in this application.

Construction and calibration

The design has been kept as simple and inexpensive as possible and its construction on a prototyping (Vero)board should not present any trouble to the hobbyist with some experience.

Preset P1 enables the frequency of the sawtooth generator to be set to your own individual taste. The frequency, f , is given by $f = 1/(C1(P1 + R1))$ Hz. With values shown, the frequency can be set anywhere between 0.2 Hz and 4 Hz, corresponding to periods of 5 s and 250 ms respectively. Because IC2 inverts the sawtooth waveform, its output would normally be mostly negative. As stated, this cannot be tolerated as it would block the OTAs. Therefore, the

inverted sawtooth voltage is superimposed on a d.c. voltage, the level of which is preset by P2. If an oscilloscope is not available, the presetting can be done by ear. Apply a signal to one of the input channels and set the LFO to a low-frequency output. If P2 has been set correctly, the loudspeaker volume should gradually fade away and then gradually swell again. If not, limiting is taking place and this is indicated by an absence of sound for some time followed by a sudden burst of volume.

The audio input signals to the circuit may lie between 0.7 V and 10 V. However, when you use inputs of just about 0.7 V and have a powerful main amplifier connected to the output of the gyrophone, it may happen that the maximum and minimum values of the sawtooth voltage become audible in the loudspeakers. This can be prevented by increasing the signal input by, for instance, inserting an additional amplifier between the signal source and the inputs to the gyrophone.

We shall be very brief about the required mains supply: the current consumption of the gyrophone is around 50 mA per channel at ± 15 V.

Figure 2. It is clear from this circuit diagram that only inexpensive and easily available components have been used. Only the setting of P2 may test your patience! (and your hearing!).

how accurate is your watch?



Even though quartz watches seem to have almost completely supplanted their mechanical counterparts, for many people there is still nothing to compare with the fine mechanical craftsmanship that goes into a clock-work watch. That regular tick, coming from so many carefully made parts, tirelessly assembled to make one whole unit, is something completely different from the invisible, silent shuffling of electrons in a quartz controlled watch.

The 'watch tester' described in this article is a crystal controlled circuit that is used as an aid to set a mechanical watch accurately. A crystal is used as a reference to determine, within a few seconds, how much time the watch gains or loses, and this is shown on a display as a certain number of minutes per day. Knowing the error is essential to be able to set the watch accurately.

how accurate is your watch?

quartz
precision for
mechanical
watches

Man has always tried to measure time in one way or another. Sundials, water clocks, oil lamps, candles and hour glasses are just some of the things that have been used to measure time down through the ages. Then came the mechanical clock. Nobody knows for certain exactly when this first came into existence but they have been made at least since the fourteenth century. Since then, mechanical clocks have been consistently improved and refined.

Watches have been made since about the end of the fifteenth century, but it took a long time before the 'portable clock' was improved enough so that it worked reasonably accurately. The best clocks in the seventeenth century had an error of about a minute per day. With an average watch an

error of a quarter of an hour a week could be expected.

Until the beginning of this century watches were normally carried on a chain and it was only around the year 1900 that somebody came up with the idea of a wrist watch. Since then watches developed very quickly. In 1924 the automatic wrist watch arrived and after the second World War the 'electric' watch. In 1957 a watch appeared on the market that used an electromagnetic system to drive the balance weight. Four years later the firm of Bulova produced a much more interesting idea, using an electronically driven tuning fork instead of the balance weight. This tuning fork watch was guaranteed to be accurate to within one minute per year!

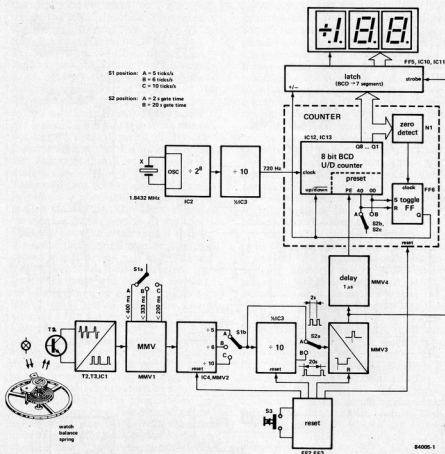

The modern watch is the final stage (so far) and uses a quartz crystal as the time base. The accuracy of this design is such that the error per year is negligible.

A mechanical watch always has much more charm than its 'cold' electronic counterpart. It is a testament to the skill of the craftsman who made it, and this alone is a great point in its favour. Clockwork watches do have one undeniable advantage, of course: they have no batteries to fail at the most unexpected and inconvenient moment.

There are, of course, still a lot of mechanical watches in circulation and several firms currently sell clockwork watches at the 'expensive' end of the market. Mechanical 'tickers', it seems, are always in fashion. Adjusting a mechanical watch is a lengthy process because changing the effective length of the balance spring does not give an immediately noticeable change. A good watchmaker, certainly, has expensive equipment that can measure the error fairly quickly, but anybody else simply could not afford one. With the watch meter here anybody can quickly adjust almost any clockwork watch accurately.

acoustic pick-up should also be possible but in practice that seemed to be more susceptible to problems with ambient noise. With this optical pick-up we use a small lamp to shine light on the spokes of the balance wheel and the reflections are received by a photo transistor. The pulses given by the photo transistor are processed and compared with a 'standard' frequency, and the error is then shown on a display.

The block diagram of figure 1 is a bit more complex than our usual circuits, but this simply makes the circuit easier to understand. The photo transistor pulses are converted to 'proper' digital signals in the

Figure 1. The block diagram of the circuit. The pulses picked up at the balance wheel of the watch can be converted to a measuring signal with a time of 2 or 20 seconds. This signal is compared to a reference time and the error is shown on a display.

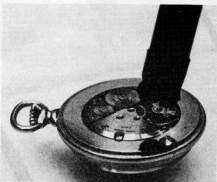

The block diagram

This circuit uses an optical pick-up. An

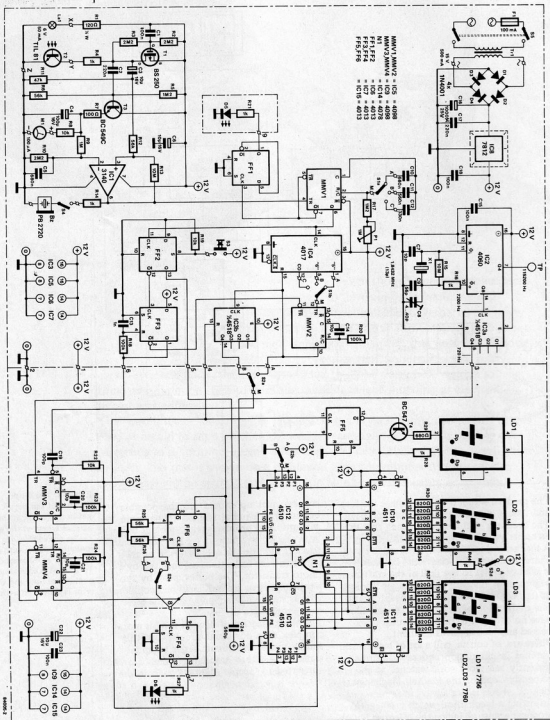

Figure 2. The various sections of the block diagram can easily be recognized in the circuit diagram here, especially as the make-up of each block is indicated in the block diagram.

first block. These pulses then go to a monostable multivibrator. The monostable time can be set to three different values with switch S1a. These values are < 400 ms, > 333 ms and < 200 ms, and they require a short explanation.

Almost every mechanical watch falls into one of two standard tick frequencies, namely 18000 ticks per hour (= 5 ticks per second) or 21600 ticks per hour (= 6 ticks

per second). The first generally applies to older watches. There are also some clocks that beat with 36000 ticks per hour (10 ticks/s). One complete swing of the balance (from the middle to one side, back to the other side and to the middle again) consists of two ticks. Five ticks then consist of 2.5 swings. Because we want to measure swing times with this circuit the MMV time must be chosen so that only every second

tick is registered. In other words the MMV time must be about 5... 10% less than the time for two ticks. For 5 ticks per second the MMV time must be relative to $2 \times 200 \text{ ms} = 400 \text{ ms}$. This drops to 333 ms for 6 ticks and 200 ms for 10 ticks.

The MMV is followed by a divider that, depending on the position of S1, divides by 5, 6 or 10. A signal with a period of 2 seconds now appears at the wiper of S1b (provided that S1 is in the correct position for the watch under test). If the period is not 2 seconds, this means that the watch is not keeping time. A period of less than 2 seconds means that the watch is running fast, and more than 2 seconds means it is running slow.

This signal then goes to switch S2a which enables us to select the 2 second signal or one ten times as long. The 20 second signal 'contains' a greater number of ticks and is therefore better than the shorter time for measuring the error of a watch. The signal chosen with S2a then goes to MMV3 and MMV4, which drive the counter and the latch. The latch with a seven segment decoder is driven by a pulse supplied by MMV3, while MMV4 presets the counter after the count has been stored in the latch (and shown on the display).

Finally, the counter. Because we want the display to show the error in minutes per day, the counter has to be a bit special. It must be able to count positively and negatively as we can have an error in either direction. The clock frequency of the counter must be carefully chosen to enable the read out to be in minutes per day. Furthermore the counter must be capable of being preset, so that its output is exactly zero if the watch is working accurately. To enable all this to be done, an eight-bit BCD up/down counter is used. Now to the clock frequency. There are 1440 minutes in a day (except Monday, which has at least twice as many). If a measuring time of two seconds is used, the counter must receive 1440 clock pulses in these two seconds. The error measured by the counter relative to this 1440 is then

the error in minutes per day. If a time of 20 seconds is used the counter must count 14400 clock pulses. This means that the clock frequency for the counter must be $1440/2$ (or $1400/20$) = 720 Hz. This reference frequency is supplied by a crystal and a few dividers.

With a measuring time of 2 seconds the preset value of the counter must be -1440 so that the count is exactly zero if the watch is running correctly. The counter can actually only count from -99 to +99, so a preset value of -1440 is impossible. Because the read out only shows two figures, we set the preset to -40 (the last two digits of -1440). The counter will then be at zero after two seconds. This 'trick' works here because a normal watch will never have an error of more than 99 minutes a day. The counter starts by counting from -40 to zero then from zero to 99 and six times from -99 to +99 and finally from -99 to zero making 1440. Note that there is a delay of one clock cycle every time the count crosses zero on its 'jump' from +99 to -99. Without this our arithmetic would not be correct. If 20 seconds is used as the measuring time the counter is preset to zero (the last two digits of 14400).

In practice the counter cannot itself work out if its count is positive or negative, so the '+' or '-' sign is stored by a flip-flop. This flips (or flops) every time the counter is at zero, and drives the \pm sign in the display. Finally there is a reset circuit whereby all counters can be reset simply by pressing one button. The circuit is then ready to begin measuring anew.

The practical layout

As we have spent quite a long time talking about the block diagram, we do not really need to say much about the actual circuit diagram of figure 2. The block diagram also simplifies matters by stating which components make up each block.

We will have a look at the input stage separately. The d.c. voltage setting of photo

how accurate is your watch?

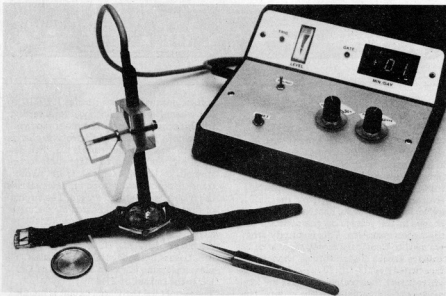

how accurate is your watch?

3

Parts list

Resistors:

- R1 = 120 Ω 1/2 W**
- R2, R3** R10 = 2M2
- R4, R14, R16, R21, R27, R28, R44 = 1 k
- R5, R17 = 1M2
- R6, R12, R25, R26 = 56 k
- R7 = 100 Ω
- R8, R19, R22 = 10 k
- R9 = 1 M
- R11 = 47 k
- R13, R15 = 10 M
- R18, R20, R23, R24 = 100 k
- R29 = 680 Ω
- R30 ... R43 = 820 Ω
- P1 = 1 M preset

Capacitors:

- C1, C15, C18, C23 = 100 n
- C2, C17 = 220n
- C3, C6, C22 = 10 μ /16 V
- C4 = 100 μ /16 V
- C5, C10 = 680 n
- C7, C14, C20, C21 = 10 p
- C8 = 4 ... 40 p trimmer
- C9 = 56 p
- C11 = 560 n
- C12 = 330 n
- C13 = 1 n
- C16 = 1000 μ /25 V
- C19 = 100 p
- C24 = 560 p

Semiconductors:

- D1 ... D4 = 1N4001
- D5, D6 = LED
- LD1 = 7756 universal overflow ± 1 display
- LD2, LD3 = 7760 common cathode seven segment display
- T1 = BS 250, BC 516*
- T2 = T1L 81**
- T3 = BC 549C
- T4 = BC 547
- IC1 = 3140
- IC2 = 4060
- IC3 = 4518
- IC4 = 4017
- IC5, IC9 = 4098
- IC6, IC7, IC15 = 4013
- IC8 = 7812
- IC10, IC11 = 4511
- IC12, IC13 = 4510
- IC14 = 4078

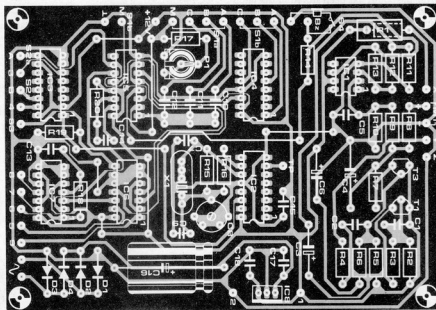
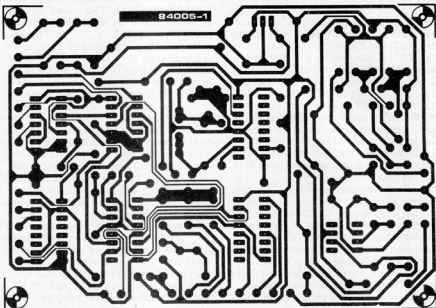
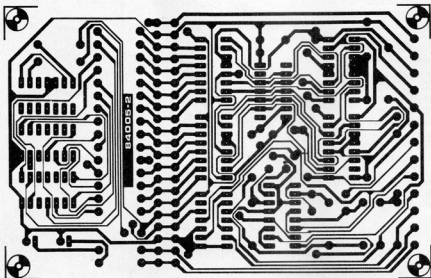

Figure 3. This is the printed circuit board design for the measuring section of the circuit.

transistor T2 is handled by FET T1. For low frequencies and d.c., T1 acts as a voltage source; its drain voltage is then fed back to the gate via R2. The low-pass filter consisting of R3 and C1 ensures that T1 acts as a current source at higher frequencies. Slow variations in the light picked up (from ambient conditions for example) are therefore compensated by the FET, while fast changes in light cause a large change in the voltage on the collector of the photo transistor. This is exactly what we need to detect the moving spokes of the balance wheel. These voltage changes are transmitted via C2 to T3 where the pulses are rectified. The voltage on C4 is the same as the maximum value of the pulses. This

voltage goes via voltage divider R9/R10 to IC1 where it acts as the trigger-level setting for this schmitt trigger. The other input of the schmitt trigger is fed the voltage changes from the photo transistor via C3. This set-up allows the circuit to adapt itself to the strength of the input signal. If the photo transistor provides a strong input signal then the triggering threshold is high. The strength of the input signal is indicated by the meter connected parallel to C4. If switch S4 is closed the output of IC1 is heard through the buzzer. An LED, D5, at the Q output of FF1 flashes in time with the tick pulses. The measuring time is shown by means of LED D6 at the output of FF4. The supply for the whole circuit is handled



Miscellaneous:

Bz = buzzer, Toko 2720

F1 = 100 mA slow blow

fuse and holder

heatsink for IC8

La1 = 6 V/50 mA

miniature lamp**

M1 = moving coil meter

100 μ A FSD

S1 = 2 pole 3 way switch

S2 = 4 pole 2 way switch

S3 = push button

S4 = single pole toggle

switch

S5 = double pole mains

switch

Tr1 = mains transformer,

15 V/500 mA

X1 = crystal, 1.8432 MHz

(13 pF)

* If T1 is BC 516,

R3 = 3M9

** Reflection sensor

OPB 730 can be used

instead of a lamp and

photo transistor; then

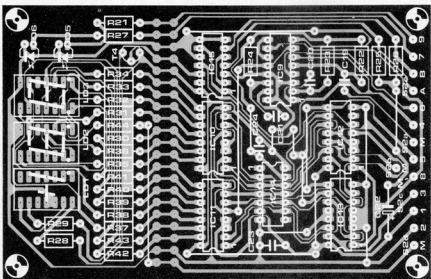
R1 = 560 Ω 

by the same 7812 regulator IC. The current consumption is about 250 mA.

Constructing the circuit

The circuit has been divided between two printed circuit boards that are shown in figures 3 and 4. The 'measuring' section is located on the board shown in figure 3 and contains all the components shown in the left half of the circuit diagram, with the exception of R21 and D5. The second board consists of two sections which may be separated if desired. These are the counter section and the read-out (the right half of the circuit diagram with the exception of FF4). The numbered points on the two

boards must be connected to each other. The supply for the display *must* be taken from points 1 and 2. Trying to tap a supply from anywhere else will probably cause problems.

It is quite possible that the BS 250 FET may prove difficult for some people to get their hands on. If this is the case, a BC 516 may be substituted for T1, but R3 must then be 3M9. Fortunately this transistor can be fitted to the board exactly the same as the FET.

When all the electronics is assembled we can turn our attention to building the sensor. The photo transistor and the lamp are mounted next to each other, but in such a way that the light from the bulb does not

Figure 4. The printed circuit board for the counter section and the read-out, which can, if desired, be separated to enable the display to be mounted away from the counter.

fall directly on the photo transistor. This is easily done with a piece of black paper between the two. The emitter of the transistor can now be soldered directly to the collar of the lamp. This leaves three connections which can be linked to the printed circuit board with a piece of screened stereo cable. The collar of the lamp (which can be a miniature type) must be connected to the screen. This unit can then be fitted into something like a big felt tip pen. A clip can be made up to hold this 'pen' steady during a measurement. The photos and the front cover show how our prototype was built. A nicer (but also more expensive) possibility is to use a reflection sensor, such as the OPB 730, which contains a LED and a photodarlington. If this is done the sensor must be well screened from ambient light, and the value of resistor R1 must be increased to 560 Ω .

Adjustment and use

Adjustment is very easy. The frequency of the crystal can be set to the exact value required with trimmer C8. To do this a frequency meter with a maximum error of 0.005% is needed. A frequency of 115200 Hz must be measured at test point TP. If you cannot get hold of a good frequency meter then simply put C8 in mid position. In most cases the frequency will then be reasonably accurate.

Next, MMV1 must be set, preferably with an oscilloscope. Potentiometer P1 is set so that the monostable time is 360...380 ms with S1a in position A. If you do not have an oscilloscope, this MMV can also be adjusted with the aid of a watch that is known to be accurate. Place the watch under the sensor and turn the sensor until the meter shows a strong signal and the buzzer ticks regularly. Turn the preset to maximum, set switch S2 to position A (2 s measuring time) and adjust the preset by turning it backwards a little at a time. After each adjustment wait until the measuring time has passed and see what the read-out shows. At some stage an error of about zero minutes will be displayed. Turn the preset a little bit further and then leave it at that.

A few words about using this circuit will certainly not go astray. First we must know the tick frequency of the watch to be tested. Older gents watches generally have 5 ticks per second, whereas modern gents watches and ladies watches usually have 6. After a bit of practice this can even be heard from the ticking of the watch. Lay the watch under the sensor and point the photo transistor towards the spokes of the balance wheel. Move the watch carefully until the meter reading is as large as possible. If S4 is closed the pulses from the phototransistor can be heard from the buzzer. This should be a regular tick. If it sounds more like 'sawing' then the transistor is pointing at the adjusting screws and must be moved slightly.

The COUNT LED, D5, should flash regularly to show that the circuit is receiving the pulses. The correct ticking frequency (5, 6, or 10 ticks per second) must be set with S1.



A measuring time of 2 seconds is selected using S2. Press the RESET and after 2 seconds LED D6 (GATE TIME) 'changes'. What we mean is that the LED lights if it was out and it goes out if it was lit. The display now shows the error in minutes per day. Whenever D6 changes the measurement has been taken and the result is shown on the display.

If the error of the watch is less than ten minutes, S5 can be moved to position B (20 s measuring time). First press the RESET again and after 20 seconds LED D3 changes and the error is shown on the display in tenths of minutes.

With a pocket watch the photo transistor can also be focused on the balance screws and this usually gives good results. In this case, however, it is important to reduce the level of ambient light as much as possible. Incandescent lamps and fluorescent tubes in particular can cause problems.

A period counter could also be used in the circuit in place of the counter section and read-out. It is simply connected to the wiper of switch S2a. However, IC2, IC7, X1, C7, C8, C9, C13, R15, R16 and R18 can then be removed and point 4 of the measuring board and pin 1 of IC3 must be connected to earth. The read-out on the meter will not, of course, be in minutes per day any more. It is a simple matter to convert the output to minutes per day using the formula $60 \times 24 \times (2 - T)/T$, where T is the period measured in seconds. If T is 1.986 seconds the error of the watch is $60 \times 24 \times (2 - 1.986)/1.986 = +10$ minutes per day.

how accurate is your watch?

A mechanical watch works with almost incredible accuracy considering that it has to tick nearly a half million times per day

A mechanical chronometer has an error of one minute per month at most; with an automatic watch that is about one minute per week.

S1 position: A = 5 ticks/s
B = 6 ticks/s
C = 10 ticks/s

S2 position: A = 2 second gate time
B = 20 second gate time

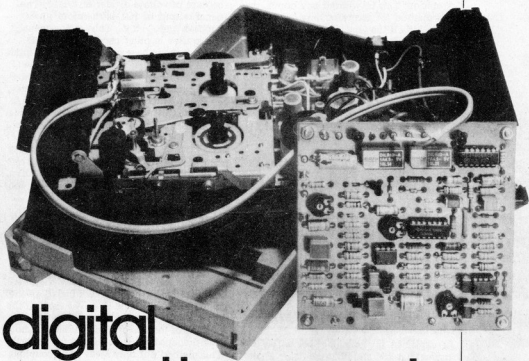

digital cassette recorder

Cassette recordings are still the most popular memory for home computers because they offer the cheapest method available. Unfortunately, it is not the most reliable method because a cassette recorder is, after all, intended for processing audio rather than digital signals. The present circuit converts a normal cassette recorder into a digital one with vastly improved data transfer capability without the loss of the audio facility.

Most home computers have a cassette recorder interface which usually obeys a simple rule: the cheaper and simpler the computer, the worse the data transfer to the recorder. This only becomes evident, of course, when you 'read' a newly loaded program and find that all is not what it's supposed to be. Why is that? And can anything be done about it?

In most computers, a signal is delivered to the interface which is not really suitable for an audio cassette recorder. The amplitude of the signal is normally limited to prevent the overloading of the recorder, while a transfer speed is chosen which, according to the computer manufacturers, is 'safe'. In other words, the computer is adapted to the cassette recorder without too much thought to the fact that the recorder was designed for a different purpose.

We have tackled the problem from the opposite direction by matching the recorder to the computer. A 'read' (playback) and a 'write' (recording) amplifier are added which improves the data transfer to the extent that baud rates of 4800 may be used! When you consider that the baud rate in most, if not all, home computers cannot exceed a three-

figure number, you realize what a considerable improvement our circuit offers.

Analogue and digital recording

The (analogue) recording of audio signals onto magnetic tape requires special circuits to ensure that the playback signal is a faithful reproduction of the original. After all, Dolby and DBX did not come about by accident! One of the important design considerations, for instance, is to prevent saturation of the magnetic tape (as saturation would cause distortion).

A square-wave pulse, as generated by most computers, consists of a large number of sinusoidal voltages. As the recording/playback amplifier of a recorder is optimized for audio signals, it will suppress a number of constituents of such a pulse. The result is that what's recorded is no longer a square-wave signal. Further disintegration of the pulse takes place during playback, there is the tape noise, and ... The consequence of it all is that the Schmitt trigger normally found in the input stages of a cassette interface is not presented with one proper pulse, but several distorted ones.

... ensures
your bits stay
on the tape

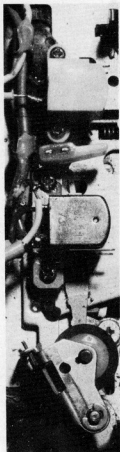

Figure 1. The only modification to the recorder is in the cable to the tape head. The existing amplifier remains untouched and fully usable for audio operation.

The process in a digital recorder is much simpler: the magnetic tape is driven into saturation. This is, without any doubt, the best method for recording data onto tape, particularly if the tape is positively magnetized during logic 'high' signals and negatively during 'low' signals.

Before we analyze the circuit diagram, a reassurance about the cassette recorder: it needs only one modification. The screened cable to the tape head needs to be cut and the digital read/write amplifier inserted between the cut ends as shown in figure 2. The audio recording/playback amplifier is not touched at all so that the recorder remains fully usable for normal audio operation.

The circuit

The write/read (recording/playback) amplifier consists of two functional units separated by the switch-over unit (see figure 1). The read amplifier is constructed in two parts to which we'll come back in the circuit description. Other items shown in figure 1 are the write and read indicator LEDs.

Write (recording) amplifier

As explained in 'switching' below, we'll assume that ES1 and ES2 (see figure 2) are closed and that contacts Re1 and Re2 are open.

The square-wave pulses from the computer are applied across preset P1 and from there fed to the inverting input of opamp IC1 via R1 and C1. Diodes D1 and D2 limit the signal to ± 0.7 V. The gain of IC1 is fixed at about 100 by voltage divider R2/R3. Anti-parallel connected diodes D3 and D4 in the feedback loop limit the output of the opamp to ± 0.7 V. Plus or minus? you may ask. Surely the supply voltage is +12 V only?

True, but the non-inverting input of IC1 does not lie at earth potential but at +6 V because of voltage divider R12/R13. The signal output of IC1 is therefore superimposed onto +6 V. This arrangement is also used in other parts of the circuit.

Figure 3 shows how a sinusoidal (FSK) input signal is converted by this method: the frequency remains unchanged, but the waveform becomes rectangular. You can well imagine that if a sine wave is so converted, a distorted rectangular pulse will certainly be fully resorted to its original shape. We have taken an FSK signal as an example because that shows the operation of the circuit most clearly. In general, our digital recorder is not required with computers which have an FSK output, but as this example shows: you never know . . .

The rectangular output of IC1 is inverted again by trigger A1 and increased to the maximum possible level of 12 V_{pp} (wave shape 4, figure 3).

The output of A1 is split: one part is applied to terminal 'A' of the tape head via R32 and ES1; a second is again inverted by trigger A2 and then fed to the earth terminal 'B' of the tape head via R33 and ES2. The signal at the tape head is therefore the difference in outputs of the two opamps A1 and A2: note that the tape head is not connected to earth. This method not only saves some coupling capacitors (which might distort the signal slightly) but, what's far more important, the tape magnetization for a logic low signal is the opposite of that for a high signal.

Switching

A third part of the output of A1 is applied to the electronic switching circuit via C3. This circuit consists of electronic switches ES1 and ES2, relays Re1 and Re2, diodes D7 and D8, and a few resistors and capacitors.

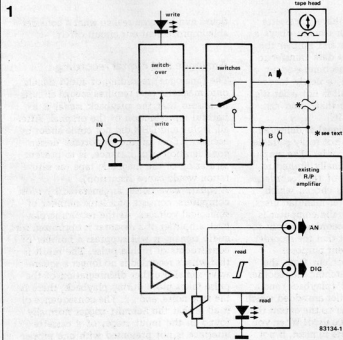

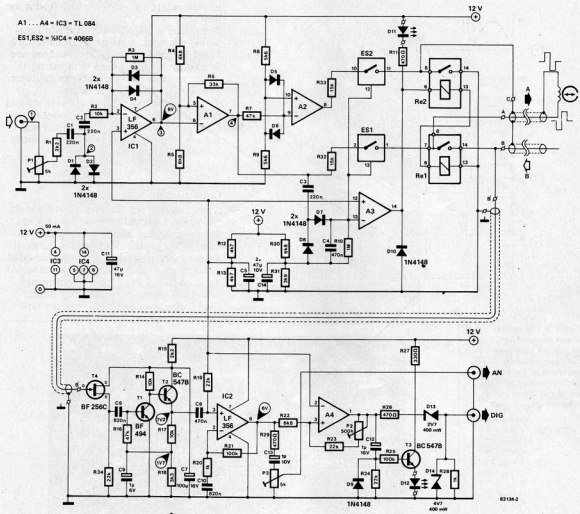

The non-inverting input of comparator A3 is at a level of about +6 V via voltage divider R12/R13. Under no-signal conditions, the inverting input is at about +4.4 V via voltage divider R30/R31. The output of A3 is therefore at +12 V and relays Re1 and Re2 are actuated. The voltage at the inverting input also exists at the inputs of electronic switches ES1 and ES2, but is not sufficient to close the switches: a voltage close to the supply voltage is required to do that. Summarizing: under no-signal conditions, ES1 and ES2 are open and the contacts of Re1 and Re2 closed. The circuit is then in the 'read' condition.

When a signal arrives from the computer, the output of A1 is applied to the control inputs of ES1 and ES2, and to the inverting input of A3 via C3 and D7. The output of A3 goes low, the relays open, and ES1 and ES2 close. The circuit is then in the 'write' condition. Capacitor C4 charges and continues to do so as long as there is a signal coming in from the computer. As the input current of A3, ES1, and ES2 is very small, the charge on C4 is sufficient to keep the switching circuits

in the same state even during the pauses between the pulses. When the computer signal ceases, C4 discharges through R10 and the circuit reverts to the 'read' condition.

Read (playback) amplifier

In the 'read' condition, Re2 connects the earth terminal of the tape head to the circuit earth (0 V). The tape signal is connected via Re1 to the gate of FET T4. This small-signal amplifier is followed by a second consisting of T1 and T2, and a third formed by IC2. To ensure that the maximum signal is available at the output of IC2, its input is 'raised' to about 6 V, derived from the voltage divider R12/R13. The total gain of the three stages is around 80 dB, of which half is contributed by IC2. This is ample for many computers and the output of IC2 is therefore available at terminal 'AN'. The output level can be matched to the computer input requirement by preset P3. For those situations where more gain is required, a fourth amplifier, A4, has been provided. The gain of this amplifier can be

Figure 2. The new amplifier consists of three parts: a recording (write) and playback (read) amplifier and a switching circuit which separates the two amplifiers.

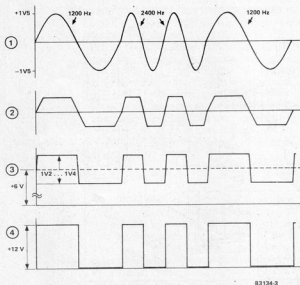

83134-3

Figure 3. The various phases of signal conversion are clearly seen in this representation. The operation of the circuit can be checked with the aid of this figure and an oscilloscope.

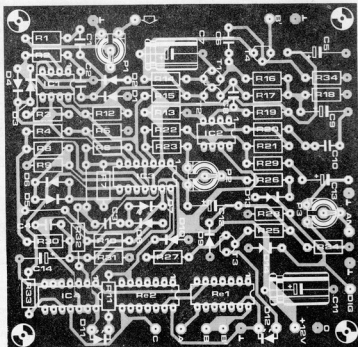

Figure 4. The printed-circuit board is double-sided, and the component layout side takes the form of an earth-plane.

set between 17 dB and 37 dB by preset P2. As A4 is driven into saturation, its output is virtually identical with signal 4 in figure 3. The output is raised to TTL-level via voltage divider R26/D13/D14 and made available at terminal 'DIG'.

A few further points

To avoid confusion, some aspects of the circuit have been ignored so far. To start with: LED D11. This lights when the output of A3 is low, that is, during the 'write'

condition. It is possible that it continues to light faintly during the 'read' condition; if you find this disturbing, the only solution is to replace D11 by a cheaper LED (giving less light).

Then there is LED D12. This diode lights during the 'read' condition. Capacitor C12 keeps T3 conducting so that this does not switch on and off in time with the input signal. Resistor R25 prevents the indicator circuit affecting the output signal. Finally, diode D10. This component appears to be located in a somewhat strange position, but a good look at the circuit will show that it functions as a protection diode for relays Re1 and Re2.

Construction and calibration

Assembling the printed circuit board should not present any difficulties: figure 4 and the parts list give all the information required. One point needs watching, however. Although we are dealing with a double-sided board, the two points 'B' must be connected by means of a short length of screened cable. The reason for this is that during 'read' operation the signal from the tape

head is very small (remember the 80 dB gain!). For the same reason, the screened cable between 'A' and the head must be kept as short as possible. In contrast to audio circuits, there is no central earth point here, so that the earths at both sides of the cable must be connected with one another. The circuit is very simple to set up. The correct positions of P1...P3 are dependent upon the type of computer and on the baud rate. If you start at the centre position of these presets and have checked that the d.c. levels shown in the circuit diagram are

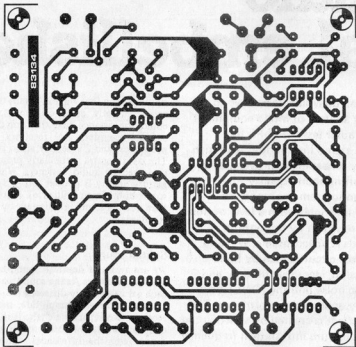
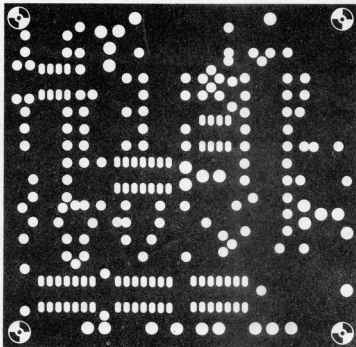

Parts list

Resistors:

R1,R15 = 2k2
 R2,R14,R17 = 10 k
 R3,R10 = 1 M
 R4,R5,R22,R30 = 6k8
 R6 = 33 k
 R7 = 47 k
 R8,R9 = 5k6
 R11,R26,R29 = 470 kΩ
 R12,R13 = 4k7
 R16 = 47 k or 47k5,
 metal film, 1%
 R18 = 3k3
 R19,R23,R24,R34 = 22 k
 R20,R28 = 1 k
 R21,R25 = 100 k
 R27 = 330 kΩ
 R31 = 3k9
 R32,R33 = 15 k
 P1,P3 = 5 k preset
 P2 = 500 k preset

Capacitors:

C1,C2,C3 = 220 n ceramic
 C4,C8 = 470 n ceramic
 C5,C14 = 47 μ/10 V
 electrolytic
 C6,C10 = 820 n ceramic
 C7 = 100 μ/16 V
 electrolytic
 C9 = 1 μ/6 V electrolytic
 C11 = 47 μ/16 V
 electrolytic
 C12,C13 = 1 μ/10 V
 electrolytic

Semiconductors:

D1 ... D10 = 1N4148
 D11,D12 = LED
 D13 = zener diode 2V7,
 400 mW
 D14 = zener diode 4V7,
 400 mW
 T1 = BF 494
 T2,T3 = BC 547B
 T4 = BF 256C
 IC1,IC2 = LF 356
 IC3 = TL 084
 IC4 = 4066B

Miscellaneous:

Re1,Re2 = DIL relay,
 e.g. ERNI 10L34 (4.5 ...
 5.0 V/1 A)
 PC Board 83134

OK (no-signal conditions), the right settings should soon be apparent.

Final tip: load a not-too-small memory region of the tape with a fixed hex-value and program a loop. It is then possible with the aid of an oscilloscope to check the conversion of the signal (with reference to figure 3) at various test points. During 'write' operation simply run the tape with this fixed hex-value. It is, by the way, not necessary to press the 'record' button during 'write' operations to erase any material already present on the tape because

the signal now fed to the tape head is considerably stronger than the previous recording.

Current consumption of the circuit is around 50 mA and it may therefore just be possible to draw this from the existing recorder power supply.

M



audio signal embellisher

from an idea by
J.F. Brangé

signal
restoration
with stereo
simulation

It is often unavoidable to have to connect an item of mono equipment that is rather less than hi-fi to a modern stereo installation. Although this may give some improvement in the resulting sound quality, the reproduction remains monaural (mono) invariably with a level of hum and noise which by present-day standards is unacceptable. We have designed a circuit which by hum suppression, stereo simulation, and dynamic noise limiting (DNL) gives a greatly enhanced performance. The stereo effect is created by splitting the audio spectrum into sixteen frequency bands which are fed alternately to the left and right-hand channels.

Ever since the arrival of hi-fi audio equipment and the introduction of stereo, our aural senses have been spoilt to the point of addiction. Nowadays when we listen to ordinary monaural music, we soon feel there's something missing. If in addition the sound is accompanied by hum and noise, this feeling soon becomes one of disappointment or even annoyance. However, sometimes there is no alternative to the poor sound source, if only for the

simple reason that we don't want to throw away perfectly good equipment. This could, for instance, take the form of simple cassette recorders, AM receivers, sound projectors, and TV sets or video recorders. The last three are particularly prone to being neglected by audio designers. While the picture quality is praised (often deservedly so) as hi-bri (high brilliance), more often than not the sound is a disgrace by modern standards.

Spatial sound

We are aware of depth in sound because we have two ears. As the sound waves reach each ear at a slightly different time and with a slightly different amplitude, the brain receives two separate signals. It is able to deduce the relative position of the sound source from the differences: our ears form a true stereo receiver! The shape of the ear also plays a role: if you want to know more about this, we refer you to 'our remarkable sense of pitch' in the May 1979 (UK) issue of *Elektor*.

What can we do with a mono sound? It is impossible to convert it into true stereo, because the subtle differences between the left and right-hand channels just cannot be added afterwards. What we can do is to create artificial differences by splitting the sound into a number of frequency bands and then feed these selectively to the left or right-hand channel of the stereo installation. This is, by the way, the method

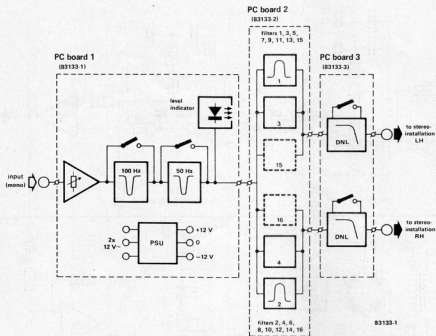

Figure 1. Block schematic of the entire circuit. The three separate modules are shown in dashed lines.

used in the TDA 3810 stereo-IC featured in 'pseudo stereo' in our November 1983 issue. The present design is rather more radical and effective: the audio spectrum is split into sixteen bands by means of active filters. If the filter outputs are numbered 1...16 in order of ascending centre frequency, all odd-numbered frequency bands are fed to the left-hand channel, and all the even ones to the right-hand channel. The result is truly remarkable: the sound, which at first seemed to come from between the speakers, now seems to 'hang in space' around the speakers.

The block schematic

The block schematic in figure 1 clearly shows that the design consists of three distinct main parts: each of these is housed on a separate printed-circuit board. The input of the circuit is a pre-amplifier (with variable sensitivity), followed by a 100 Hz and a 50 Hz band-stop filter (sometimes called a 'notch' filter). These filters respectively reject the 100 Hz fundamental frequency of a double-phase rectified voltage and the 50 Hz fundamental of a single-phase rectified voltage. Both filters can be switched out. The next element is a level indicator which is useful when the input sensitivity is set. Nothing sophisticated, just a simple amplifier and LED which blinks away quietly when the sensitivity is set correctly. Next, we come to the heart of the design: the sixteen active band-pass filters. The outputs of the odd-numbered filters, and those of the even-numbered ones, are separately combined and are then, in principle, suitable for processing in a stereo installation.

We have, however, added dynamic noise limiting (DNL) stages which, if required, can be switched off or be omitted altogether. Some of you may even use this part of the design only.

The circuit diagrams

There is a circuit diagram for each of the three main parts of the design: the pre-amplifier, band-stop filters, and power supply (figure 2), the sixteen-element active band-pass filter (figure 3), and the DNL stages (figure 7).

The pre-amplifier, band-stop filters, and power supply

The input sensitivity is preset by means of P1. Pre-amplifier A1 has a gain of about 10 dB and is followed by active band-stop filters A2 (100 Hz) and A3 (50 Hz). The output of A3 is fed to the band-pass filters on the second printed-circuit board (see figure 3), and also to the level indicator stage. After amplification in A4, the signal is applied to the base of T1 via C13. When it exceeds a certain level, T1 conducts to light LED D1.

The power supply for the entire design consists of the customary mains transformer, bridge rectifier, voltage regulators, and smoothing capacitors. The output is symmetrical: ± 12 V at 85 mA.

The band-pass filters

The sixteen band-pass filters (see figure 3) are identical in construction. The basic diagram of one of them is shown in figure 4: a common filter circuit with an opamp as the active element and RC combinations to give the required frequency response and Q factor. As you can see from the formulas

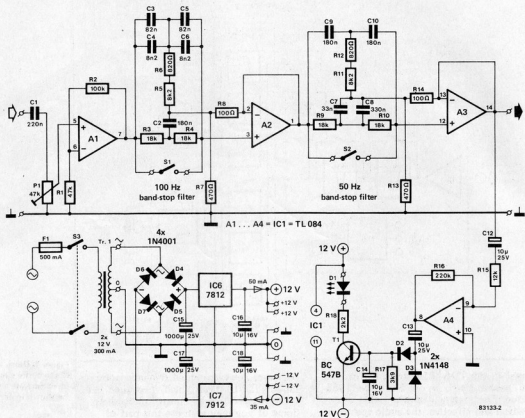

Figure 2. The circuit of the pre-amplifier, band-stop filters, and power supply.

in figure 4, if a fixed value is chosen for R1 and R2, the centre frequency becomes inversely proportional to the value of capacitance C. By appropriate values of C in the sixteen filters, the centre frequencies are varied, but the Q factor and gain A_O remain the same.

The DNL stages

For those of you who are not completely familiar with the operation of a dynamic noise limiter, here is a short description. The simplest noise limiter is a low-pass filter. Unfortunately, its action is somewhat radical and affects the audio signal. A dynamic noise limiter is a low-pass filter with variable cut-off profile which only functions during soft passages (when the noise is most audible) by suppressing those frequencies to which the ear has the highest sensitivity, that is, about 1...10 kHz. The amount of suppression is therefore dependent upon the level of the input signal. During loud passages, the cut-off frequency is shifted upwards so that the entire audio range is passed, including the noise, but this is then, of course, masked by the audio signal. At lower levels of signal input, the cut-off frequency is lowered, so that a relatively larger amount of noise is suppressed. The action of a DNL is illustrated by the graphs in figure 5: for an input signal, U_i , of 2.0 mV, the attenuation with respect to the output level at 1 kHz

is 10 dB at 7.5 kHz and 20 dB at 10 kHz. The slope is then approximately -18 dB/octave. With input signals above about 8 mV, the response is virtually flat to 20 kHz!

The input stage, A, (see figure 6) ensures correct impedance matching between the band-pass filter and the DNL. From here, the signal is fed to two channels: the upper one consists of a high-pass filter (B), amplifier (D), variable attenuator (E), and fixed attenuator (G), while the lower one comprises a phase shifter (C) and a fixed attenuator (F). The output of the DNL is the sum of the outputs of the two channels which are, of course, in anti-phase.

For low levels of input, U_i , the output, U_1 , of the phase shifter is, apart from the phase shift, identical with U_i . The output, U_2 , of the high-pass filter contains only the high-frequency content of U_i . Signals U_1 and U_2 are, as already stated, in anti-phase so that if they are summed the high-frequency content of U_i is cancelled out. The net result is therefore that of a low-pass filter. When the level of input signal rises, the variable attenuator in the upper channel comes into operation and reduces the contribution of U_2 to the output signal, U_O . The high-frequency portion of U_i is then no longer (or to a lesser degree) suppressed and U_O will tend to resemble U_i more and more. Turning to the circuit diagram (see figure 7), the input amplifier, transistor T2, in con-

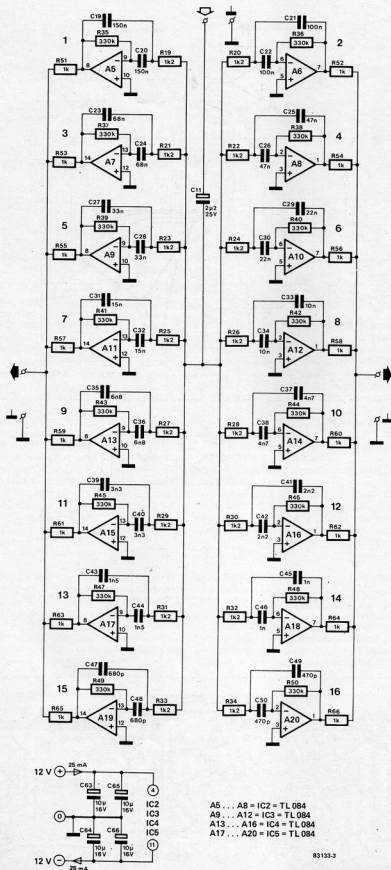

Figure 3. Circuit diagram of the sixteen-element band-pass filter unit. The stereo effect is obtained by feeding the frequency bands alternately to the left and right-hand channels.

4

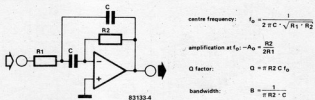

Figure 4. Basic circuit of a band-pass filter showing the formulas for calculating the various filter characteristics.

5

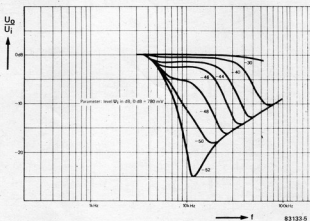

Figure 5. Transfer characteristic of the DNL; the filter action is dependent upon the level of the input signal.

6

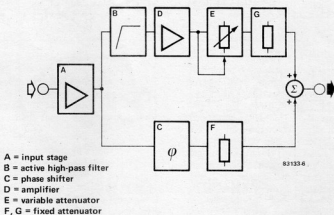
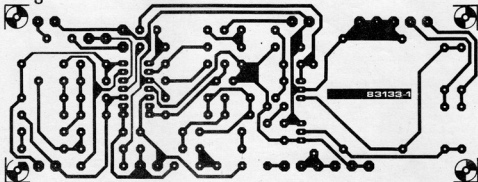
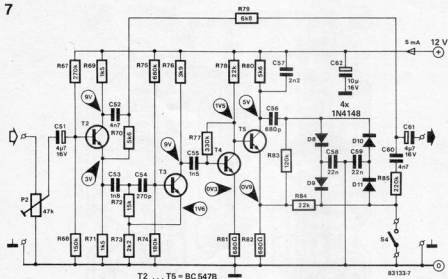

Figure 6. Simplified block schematic of the DNL.

8





audio signal embellisher

Figure 7. The circuit diagram of the DNL: two such circuits are required, one for each channel.

Parts list (DNL)

Circuit: figure 7
PC board: figure 10

Resistors:

R67, R67' = 270 k
R68, R68' = 150 k
R69, R69', R71, R71' = 1k5
R70, R70', R80, R80' = 5k6
R72, R72' = 15 k
R73, R73' = 2k2
R74, R74' = 180 k
R75, R75' = 680 k
R76, R76' = 3k9
R77, R77' = 330 k
R78, R78', R84, R84' = 22 k
R79, R79' = 6k8
R81, R81', R82, R82' = 680 Ω
R83, R83' = 120 k
R85, R85' = 220 k
P2, P2' = 47 k (50 k) preset

Capacitors:

C51, C51', C61, C61' = 4 μ 7 / 16 V
C52, C52', C60, C60' = 4n7
C53, C53' = 1n8
C54, C54' = 270 p
C55, C55' = 1n5
C56, C56' = 680 p
C57, C57' = 2n2
C58, C58', C59, C59' = 22 n
C62, C62' = 10 μ 16 V

Semiconductors:

D8 ... D11, D8' ... D11' = 1N4148
T2 ... T5, T2' ... T5' = BC547B

Miscellaneous:

S4 = DPST switch

Figure 8. Layout and component side of the printed-circuit board for the pre-amplifier, band-stop filters and power supply.

junction with C52 and R70, forms the phase shifter. The output of the phase shifter is taken to the DNL output via fixed attenuator R70/R79.

The active high-pass filter, formed by C53, C54, T3, and R72 ... 76, is followed by amplifier T4 and a variable attenuator consisting of T5 and associated components. The collector as well as the emitter of T5 feed a signal to the diode bridge D8 ... D11. Capacitors C58 and C59 are charged to the emitter voltage via R83/D8 and R84/D11 respectively. If the audio signal level lies below the forward voltage of the diodes, these will not conduct. The signal from T5 is then taken directly to the DNL output where it is summed with the signal from the phase shifter. As the two signals are in anti-phase, the cut-off frequency is about 6 ... 7 kHz and filter action is at a maximum.

When the audio signal is greater than the diode forward voltage, the diodes conduct and present a low impedance to audio frequencies. A low-pass filter is then formed by R84, C58, C59, which causes the higher frequencies to be attenuated. The end result will be that fewer (or hardly any) high frequencies are removed from the final output signal, which shows up as a flattening of the overall frequency response.

Construction

As stated before, the design is built up from three modules: pre-amplifier plus power supply plus band-stop filters, and the DNL stages. This type of construction makes it possible for everyone to choose which part(s) of the design he needs: some of you may not want the stereo effect, in which case all you have to do is omit the sixteen-element band-pass filter. If the DNL unit only is built, it is, of course, necessary to add a suitable power supply.

When the printed-circuit boards shown in figures 8 ... 10 are used, no particular problems should be encountered in the construction. During the building of the power supply, make sure that one voltage regulator IC is turned 180° with respect to the other. In view of the small current consumption, these ICs do not need heat sinks.

The band-pass filter board is best commenced by wiring in the four wire bridges which are to be located under IC2 ... IC5: this will make things a lot easier later on. The DNL board consists of two absolutely symmetrical halves: it is possible to cut it into two and have two independent mono DNLs! In contrast to the remainder of the

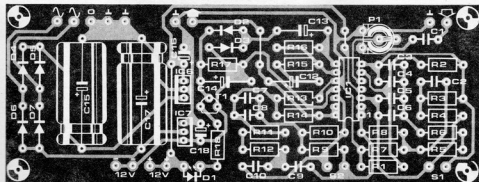

Parts list (filters and power supply)

Circuits: figures 2 and 3;
PC boards: figures 8 and 9

Resistors:

R1 = 47 k
R2 = 100 k
R3, R4 = 18 k
R5, R11 = 8k2
R6, R12 = 820 Ω
R7, R13 = 470 Ω
R8, R14 = 100 Ω
R9, R10 = 18 k
R15 = 12 k
R16 = 220 k
R17 = 3k9
R18 = 2k2
R19 ... R34 = 1k2
R35 ... R50 = 330 k
R51 ... R66 = 1 k
P1 = 47 k (50 k) preset

Capacitors:

C1 = 220 n
C2, C9, C10 = 180 n
C3, C5 = 82 n
C4, C6 = 8n2
C7, C27, C28 = 33 n
C8 = 330 n
C11 = 2 μ 2/25 V tantalum
C12, C13 = 10 μ /25 V
C14 = 10 μ /16 V
C15, C17 = 1000 μ /25 V
C16, C18 = 10 μ /16 V
tantalum
C19, C20 = 150 n
C21, C22 = 100 n
C23, C24 = 68 n
C25, C26 = 47 n
C29, C30 = 22 n
C31, C32 = 15 n
C33, C34 = 10 n
C35, C36 = 6n8
C37, C38 = 4n7
C39, C40 = 3n3
C41, C42 = 2n2
C43, C44 = 1n5
C45, C46 = 1 n
C47, C48 = 680 p
C49, C50 = 470 p
C63 ... C66 = 10 μ /16 V

Semiconductors:

D1 = LED
D2, D3 = 1N418
D4 ... D7 = 1N4001
T1 = BC547B
IC1 ... IC5 = TL084
IC6 = 7812
IC7 = 7912

Miscellaneous:

S1, S2 = SPST switch
S3 = DPST switch (mains)
Tr1 = supply transformer
2 x 12 V/300 mA
F1 = fuse, delayed action,
500 mA
fuse carrier
printed-circuit boards
83133-1 and 83133-2

Figure 9. Layout and component side of the printed-circuit for the sixteen-stage band-pass filter.

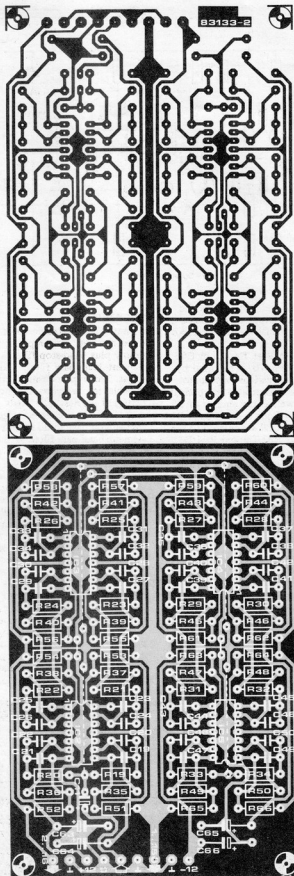

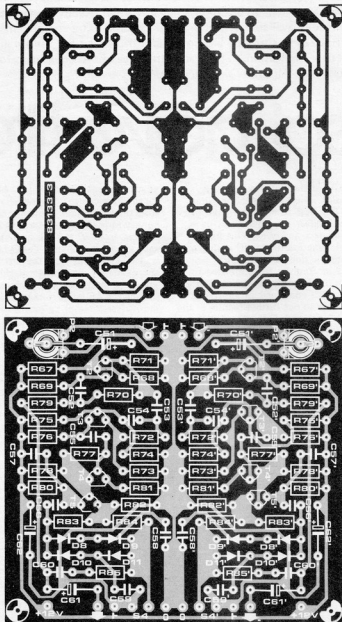

Figure 10. Layout and component side of the DNL board: as the DNL should be suitable for stereo, the board consists of two symmetrical halves.

design, the DNL needs only a single supply line: +12 V and earth.

Calibration

With the output of a tuner or record player connected to the input of the pre-amplifier board, adjust the overall sensitivity by means of P1 until LED D1 quietly blinks in rhythm with the incoming audio signal.

Because the DNL is a variable filter, the action of which is dependent upon the signal level at the base of T2, preset P2 should be adjusted carefully. Connect an a.c. voltmeter (input impedance at least 100 k Ω) between the wiper of P2 and earth, and inject a signal of about 1 V into the input terminals of the DNL. Adjust P2 for a reading 775 mV on the voltmeter. If the input signal was derived from a tuner, or record player, it may be necessary to re-adjust P1 slightly.

If you have no access to a suitable a.c. voltmeter, adjust the preset(s) by ear. Make sure that with a reasonably large input signal the high frequencies are not cut.

If that happens, the input signal is too small and must be adjusted with P2. If this has already been set for maximum sensitivity, adjust P1 also. If this still does not give a satisfactory result, the output from the signal source (tuner, record player, tape recorder) is too low, in which case an extra amplifier has to be added.

Final note:

The DNL can be inserted almost anywhere into the audio chain, but as its 0 dB input level must correspond to 775 mV it must be located before the volume control.

In audio technique, all voltages are referred to the 'normal level'. This is 1 mW into 600 Ω (= 775 mV across 600 Ω) and is conventionally designated 0 dBm.

The AF input signal is fed to the appropriate inputs of IC1 by wafer switches S3A ... S3D. The switches also ensure that unused inputs are taken to earth.

The five-bit codes for programming the Q factor and centre frequency are presented to IC1 at pins 2 ... 6 (Q) and 13 ... 17 (f_c) respectively. As a glance at table 1 will show, all that we require to generate the two five-bit codes is a pair of 5-pole 32-way switches! Yes, that's what we thought too, so back to figure 1!

Both IC2 and IC3 are 7-stage (we only use 5 here) binary ripple counters that will count up (and only up) when presented with a clock input at pin 1. This is provided by the oscillator formed by a 555 (IC4) and its associates. With the component values given the frequency is fairly low and it is possible to step the binary counters along by means of the pushbutton switches S1 and S2. The RC networks consisting of R4/C2 and R5/C3 are included to 'debounce' the switches. When the required binary number is arrived at, the switches are released and the R5620 will then be programmed according to table 1.

As stated, ICs 2 and 3 are 'up' counters only and, therefore, to return to the starting code of 00000, the entire binary code must be run through to the end. This method of operation was chosen simply for the sake of economy (it's a shade cheaper than 32-way switches anyway!) but the circuit can be modified at will.

It is a simple matter for the codes to be made visible by means of driver transistors and LEDs. In the circuit diagram these are T1 ... T10 and D3 ... D12. The bases of the transistors are connected to the terminal points at the inputs to IC1 marked A ... J.

The connections to pin 2 of ICs 2 and 3 (the 'reset' inputs) enable the two counters to be automatically set to zero when the power supply is first switched on. They also serve a second, slightly more subtle, function. In the beginning, it was said that the R5620 was also able to operate as a sine-wave oscillator. This is entirely true and for this function the output is switched back (via S3c) to the band-pass (BP) input while the LP and HP inputs are taken to earth. No problem here but there is a strange quirk in the R5620 to be taken care of. To function in the oscillator mode, the Q factor inputs (pins 6 ... 2) must be programmed to 1101. We know, because it says so in the spec. sheet! This is carried out by the four EXclusive OR gates, N1 ... N4, between IC3 and IC1. When the commoned inputs to these gates are taken low, (by switch S3d in positions 1 ... 5), the binary outputs of IC3 are unaffected and pass straight through to IC1. When the oscillator mode is selected (S3 in position 6), the commoned inputs to the gates are taken high by wafer S3d. At the same time, a reset pulse is fed to the reset input of IC3 with the result that all its outputs revert to logic zero. However, the gates now function as inverters and therefore the binary number presented to IC1 will be 1101. The R5620 will now operate as a sine-wave oscillator providing

Table 1

binary code at pins 6 ... 2	Q factor	binary code at pins 13 ... 17	f_c/f_0
00000	.57	00000	200.0
00001	.65	00001	191.3
00010	.71	00010	182.9
00011	.79	00011	174.9
00100	.87	00100	167.2
00101	.95	00101	159.9
00110	1.05	00110	152.9
00111	1.2	00111	146.2
01000	1.35	01000	139.8
01001	1.65	01001	133.7
01010	1.95	01010	127.9
01011	2.2	01011	122.3
01100	2.5	01100	116.9
01101	3.0	01101	111.8
01110	3.5	01110	106.9
01111	4.25	01111	102.3
10000	5.0	10000	97.8
10001	5.8	10001	93.5
10010	7.2	10010	89.4
10011	8.7	10011	85.5
10100	10.0	10100	81.8
10101	11.5	10101	78.2
10110	13.0	10110	74.8
10111	15.0	10111	71.5
11000	17.5	11000	68.4
11001	19.0	11001	65.4
11010	23.0	11010	62.5
11011	28.0	11011	59.8
11100	35.0	11100	57.2
11101	40.0	11101	54.8
11110	80.0	11110	52.3
11111	150.0	11111	50.0

universal active filter

pushbutton S2 is not touched! If this should happen inadvertently, simply switch S3 to another position and then back to 6.

All that we have left to discuss in the circuit is IC5 and its surrounding components. This is the clock oscillator for IC1 and its frequency is variable by means of potentiometer P2. We can now clarify the relationship between the clock frequency and the binary number that appears on pins 13 ... 17 of IC1. When the code is 00000, the centre frequency of the filter is 1/200th of the clock frequency as can be seen in table 1. It will now be apparent that the code sets the centre frequency to a ratio of the clock frequency. This gives a very wide filter response range.

Some final points worthy of note! It is of course possible to do away with the switches and counters and simply 'hard wire' the R5620 inputs to whatever function and parameters that are required. Bear in mind that 10 V can be considered as a maximum for the power supply voltage and some protection from turn-on transients must be included. The clock frequency range is fairly wide and can be anywhere between 10 Hz and 1.25 MHz.

In conclusion, the R5620 uses NMOS technology and its chances of instant death due to mishandling are inversely proportional to the quantity you have of them at that time!

The R5620 is available from:
EG and G Reticon,
34/35 Market Place,
Wokingham,
Berkshire.

Table 1. The binary programming codes for the Q factor and the ratio of clock frequency, f_c , to filter centre frequency, f_0 .

Table 2

S3 in position	filter mode
1	low pass (LP)
2	high pass (HP)
3	band pass (BP)
4	notch
5	all pass
6	oscillator (see text)

Table 2. This table shows the input selection required for the various filter modes. Refer to the text for sine-wave oscillator operation.

The LCD thermometer featured in the October 1982 (UK) issue was originally intended as an ambient temperature indicator. We don't, of course, know what you're using it for, but from the many letters we have received asking for a switched output extension, it would appear that many of you would like to use it as a thermostat. We wouldn't dream of disappointing you!

from thermometer to thermostat

from thermometer to thermostat

At first glance, the circuit does not look too exciting: a preset and a comparator. Yet there's more to it than meets the eye: after all, it has to work reliably for very long periods. Tests conducted in our own laboratories over a long period of time have proved the extension to be entirely trouble-free.

Operation is simple: if the ambient temperature rises above a value preset with P1, the relay is actuated. The relay contacts can, of course, be connected to whatever you wish: an alarm, the contacts of a room thermostat, and the like. It is also possible to have an optical warning of rising temperatures by connecting an LED and suitable series resistor (R_5) as shown in dotted lines in figure 1. In this case, the relay may not be required and R3 and R4 can be replaced by a single resistor of 10 k. And, of course, there are many other possibilities as a little thought will show.

The non-inverting input (pin 3) of the opamp, IC1, is connected to the junction of R10/R11 in the LCD thermometer. The voltage at this point is proportional to the measured temperature. A reference voltage, representing the set temperature, is preset by P1 and applied to the inverting input

(pin 2) of IC1.

If the voltage at pin 3 is greater than that at pin 2 (that is, measured temperature is higher than reference temperature), the voltage at the output (pin 6) of IC1 is high (nearly U_b). A current will then flow through R3 and R4 which is sufficient to cause a drop of about 1.5 V across R4. This is more than enough to make T1 conduct. The consequent collector current flows through the relay, Re, which is then actuated. An optical indication can also be provided by the LED.

The supply voltage for the extension can be obtained from terminal B ($+U_b$) on the printed-circuit board of the thermometer. Pin 3 of IC1 can be soldered directly to junction R10/R11, while R22 in the extension should be soldered to the junction of R11 and P2 (suitable soldering points are already provided on the printed-circuit board). Don't forget to connect the two earths together!

If the thermometer is powered from a primary battery, it would be wise to provide the power for the relay from a separate source — a low-current relay is, of course, ideal.

switched output for LCD thermometer

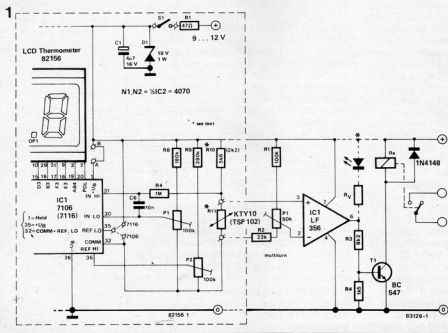

Figure 1. The circuit of the switched extension shows that it takes only a preset, a comparator, and a switching stage to convert an electronic thermometer into a thermostat.

audio sleuth at work

fault finding in audio installations

The finding of a fault in an audio system would have been very much to Sir Arthur Conan Doyle's liking. Like Sherlock Holmes, you should sit down and calmly reason out what's wrong. Take the symptoms one by one, put them in logical order and then try to find the solution by deduction.

First of all, we are not going to suggest that you open up each item of your installation, heat your soldering iron, and prepare yourself for 'surgery'. On the contrary, the hints in this article deal with fault-finding without special tools and without expensive test equipment.

As a rule, start your fault-finding with a list of questions. How did the system behave before the fault? Was everything all right? Was there any noise, hum, or crackle? Has it ever worked satisfactorily? Such a list often points to the most likely area of the fault. You then carry out a quick check of whether this is indeed so. If so, all well and good; if not, a more systematic check has to be made.

One of the quickest methods is the so-called 'halving method'. Let us assume that the fault lies in an unknown part of a chain of units or circuits. Such a chain may consist of any number of items: figure 1 shows a typical 'audio chain'.

If a signal is applied to the input of the chain and something is wrong with the output of the pre-amplifier, you know that the fault lies somewhere in that unit. Then 'halve' the possibilities, and check the signal at the tape output: if this is all right, the fault lies between there and the final output. If, however, the signal at the tape 'OUT' is faulty, the fault lies in the pre-amplifier before the tape output.

Never start with the more complicated checks but rather with the simple ones; when these give negative results, bring in the big guns. The possibilities vary from checking whether the mains plug is securely in the socket to 'open heart surgery' where

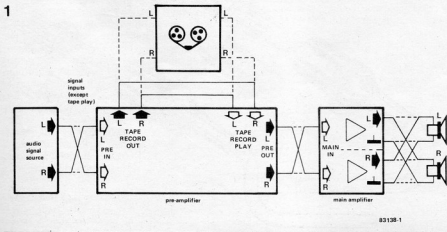

Figure 1. Possible cross-over points of the left and right-hand channels to enable the correct operation of either channel to be checked. Only one cross-over should be made at a time.

the main amplifier with the various printed-circuit boards temporarily removed is surrounded by an array of test instruments like a de luxe sine/square-wave generator, a double-beam oscilloscope, spectrum analyzer, and so on.

Checking the mains plug may sound ridiculous, but in practice many problems can be traced back to this sort of simple cause. Check therefore whether somewhere in the chain there are no controls in the wrong position, and whether all fuses are OK.

The 'interchange trick'

A check which is very suitable as an indicator is the so-called 'interchange trick' in which the left and right-hand channels are crossed over somewhere in the chain. Figure 1 shows which inputs and outputs of an amplifier can be used in such a check. If we assume that the symptom is the non-satisfactory operation of one channel, change left to right and vice versa. If now the other channel shows the symptom,

the fault lies before the point where the channels were interchanged. If the signs of disorder continue in the same channel, the fault exists after the cross-over point. Take care to make only one interchange at a time!

Restore the crossed-over point and make a similar check elsewhere in the chain. Such a check may also be combined with the 'halving' check. It is true that the number of possible interchange points in figure 1 is not great, but we felt it better not to show all the intermediate ones.

If the amplifier uses DIN connectors, an adapter as shown in figure 2 may have to be made up to enable cross-overs to be made. If 'phono' connectors are used, making an interchange is, of course, simplicity itself.

If the checks described so far fail to give the right result, the time has come to bring in the big guns! Get the temporary use of a second, soundly functioning audio system and replace one or more of the units from the malfunctioning chain by the corre-

Figure 2. Test lead for the cross-over from left to right where DIN connectors are used. The connections for the left and right-hand channels are reversed in the plug with respect to those in the socket. The test lead is then connected between the amplifier and the relevant unit (record player, tuner, and so on).

2a

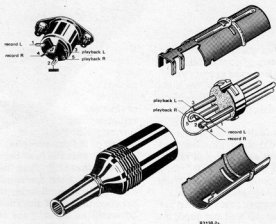

b

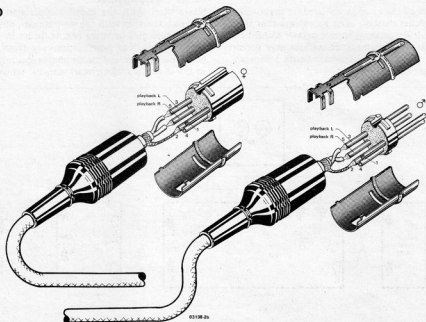

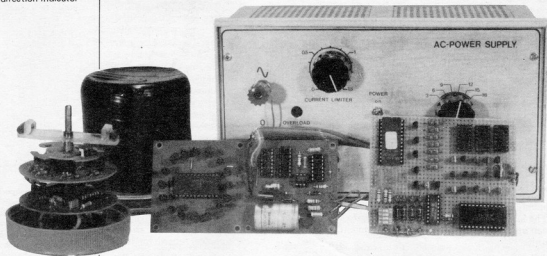

wind direction indicator

The article featuring the wind speed meter (anemometer) published in our November 1983 issue prompted us to expand the 'Elektor weather station' by adding an electronic wind direction meter. This instrument consists of a 'pick-up' and a read-out, connected together by means of two wires. The read-out indicates the wind direction with 16 LEDs. This could also be expanded so that the read-out is shown on an alphanumeric display.

R. Bakx

"revolving pointer often in shape of cock mounted in high place esp. on church spire to show whence wind blows," (OED)

In this electronic wind direction indicator the position of a wind vane is first translated into a code, which is sent below to display the wind direction on a wind compass card made up of 16 LEDs. The great advantage of the set-up used here is that only two wires are needed for interconnection between the pick-up section (at the wind vane) and the read-out section (with the wind compass). These two wires are used to provide the power for both sections and at the same time to carry the wind direction information to the read-out.

The principle

Because a simple connection between the two sections was considered important in this design, an easy method had to be found to allow both the measurement signal and the supply voltage to be transmitted over a single line. As we will see later, we solved this problem in a very unusual way. The direction of the wind is translated into a four bit code by means of a coding disc fixed to the wind vane and four reflection sensors mounted below the disc. This code must now be sent in serial form to the receiver. There the signal is reconverted into a four bit code that is used to drive the 16 LEDs of the wind compass. The block diagram of figure 1a shows the main parts of the circuit.

Before going on to look at the circuit diagram, we must first see how the power and the wind direction information are carried on the same line. This will then make the layout of the circuit much easier to understand. The diagram of figure 1b shows how this two-wire 'traffic' is achieved. In principle the supply transformer is situated between the pick-up and the read-out sections. Each section has its own supply buffer consisting of a diode and an electrolytic capacitor. Data is transferred between the two sections by means of a transistor in the 'transmitter' end and an opto coupler in the 'receiver' (display) end. The transformer is linked to the connecting cable via a diode and a resistor as shown.

Positive half-cycles of the mains frequency are now treated differently from the negative. What happens during a positive half-cycle is shown in figure 1c. The transformer voltage is half-wave rectified by a diode so that the two electrolytic capacitors are charged and the two sections of the circuit are provided with a d.c. voltage. The diodes prevent the capacitors from discharging during negative half-cycles. As we have said, the negative half-cycles are treated differently, and this is illustrated in figure 1d. If transistor T conducts the two wires are short circuited. If T is not conducting a current will flow through the LED in the opto coupler of the read-out section, so that

the opto transistor will give a pulse. The operation of the whole circuit is as easy as it is clever; when T is conducting no pulse appears at the output of the opto coupler, but when T is not conducting the opto coupler gives one pulse for each negative half-cycle. In this way signals can be transmitted during the time when there are no supply pulses on the line.

The lines therefore carry positive pulses with a frequency of 50 Hz and negative pulses 'supplied' by T. The result is shown in figure 1 d. We use the number of 50 Hz pulses between two negative pulses as

information relating to the wind direction. As far as logic is concerned, the circuit for the wind direction indicator is also split into two sections; the pick-up (figure 2) and the read-out (figure 3). We will begin with the pick-up circuit, which will later be fixed to the wind vane. The power supply for this section is handled by D5, C2, C3 and regulator IC3. The 50 Hz pulses appearing at point P are formed into a square wave by N3. High frequency interference on the lines is suppressed by RC network R18/C4. Negative signals on the line are blocked by diode D6.

wind direction indicator

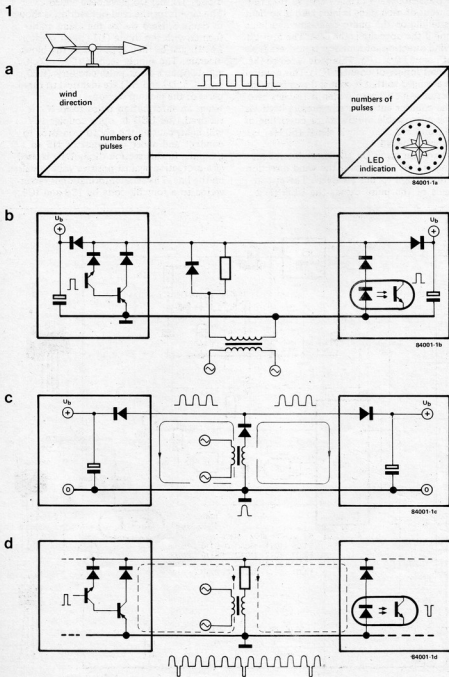

Figure 1. A rough block diagram of the wind direction indicator and three drawings to illustrate how both the power and the information signals are transmitted over the same two wires.

The wind vane is fixed to a four bit Gray code disc, by means of which 16 wind directions are coded into a four bit code. The disc contains opaque and translucent sections, and its layout is shown in figure 5. A digital signal is supplied by four reflection sensors, IC11...IC14, mounted below the disc. Alternatively, four LEDs and four photo transistors could be substituted, with the diodes shining through the disc onto the transistors. These are indicated in the parts list as D1...D4 and T1...T4, which are simply four red LEDs and four ordinary photo transistors.

The signal from each sensor is amplified by a transistor stage (T5...T8), so that the output of each stage is logic zero if no light is falling on the photo transistor and logic one if the opposite is the case. The four-bit wind direction information is now available at points P0...P3. This code is fed to the preset inputs of counter IC1. This counter is arranged so that it counts down from the preset value to zero. When it reaches zero the counter automatically presets itself via the monostable multivibrator consisting of N1 and N2. The clock signal (50 Hz) is supplied by N3.

The pulse given by N2 lasts about 5 ms and is used to transmit the wind direction information to the 'receiver'. The appearance of the pulse causes the LED (and

therefore the photo transistor) in the opto coupler to be switched off via T9, and this in turn means that T10 is turned off. The moment at which N2 gives the pulse is defined by the preset value of the counter. Because IC1 is clocked at the mains frequency, the number of mains pulses between two successive N2 pulses is exactly equal to the binary code at the preset inputs. Assume, for example, that the binary code is 1001 (= 9), then N2 will give an 'information pulse' after every 9 mains pulses. Because transistor T10 and the photo transistor in IC4 need to be protected against positive mains pulses, two extra diodes, D7 and D8, have been added.

The circuit for the read-out section is shown in figure 3. Here we see the mains transformer with the diode (D11) and resistor (R19), just as they appeared in the block diagram. The supply section (D12, C6, C7 and IC6) and clock pulse circuitry (R20, R21, C5, D9 and N4) are identical to these parts of the pick-up section.

When an information pulse from N2 is received, the LED in opto coupler IC7 will light, causing the photo transistor to conduct and short the input of N5 to ground. In this section diode D10 is used as a protection against positive voltage pulses on the line. The serial information is reconverted to a four bit code by IC8 and IC9.

Figure 2. This is the circuit diagram for the pick-up section with the coding disc and the actual sensors at the left. Depending on the code it receives, IC1 defines when an information pulse must be sent to the read-out section.

2

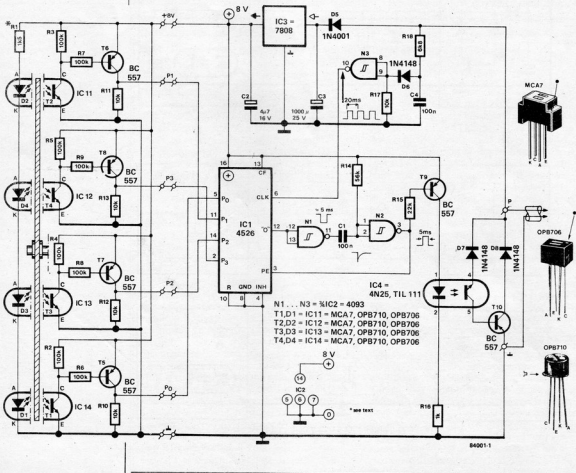

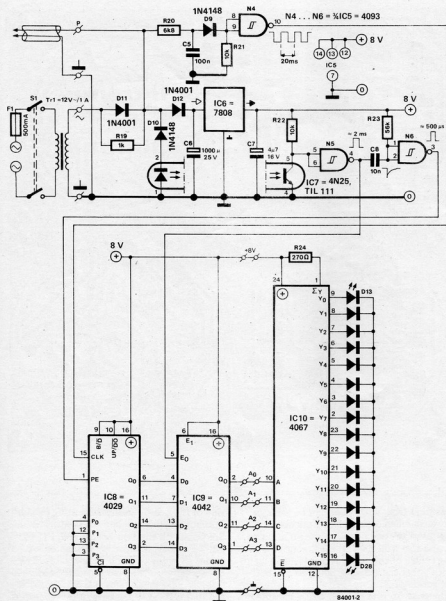

IC8 is a four bit counter that counts up from 0000 at the clock frequency. Whenever the circuit receives an information pulse the counter is reset via the monostable multivibrator of N5 and N6. Just before IC8 is reset the count is read into latch IC9 with a latch pulse from N5. The latch stores this count until a new information pulse arrives. The outputs of the latch therefore show the same four bit information that was supplied to the preset inputs of IC1. The code then goes to IC10, which acts as a 4 to 16 line decoder. The 16 outputs drive the LEDs that indicate the wind direction.

The current through the LEDs is limited to about 20 mA by resistor R24. The table beside the diagram shows the conditions for indicating each wind direction.

The mechanical layout

All the electronics we have just been describing is located on the four printed circuit boards shown in figure 4. The two circular boards contain the pick-up section, and the read-out section is on the other two boards. These four boards are supplied as one unit through the EPS service and have to be separated. The two read-out boards could also be left together, depending on the amount of room available.

The mechanical construction for the pick-up section with the wind vane is fairly straightforward. There are various details that must be considered, however. One thing that must be decided is whether to use LEDs and photo transistors or reflection sensors. The latter are recommended due to the fact that

Figure 3. This is the read-out circuit. Here the information received is converted back to a four bit code which defines which one of the 16 LEDs in the 'wind compass' will light.

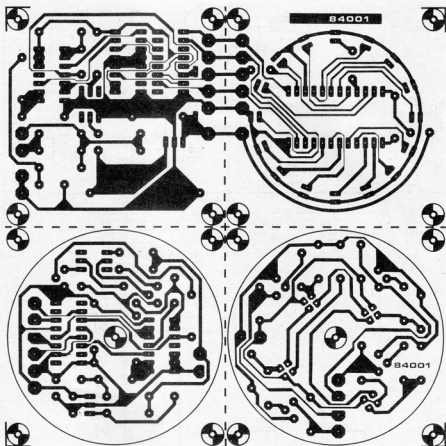

Figure 4. This is the printed circuit board layout for the complete wind direction indicator, consisting of four sections that must be separated from one another. The two read-out boards may be kept as one unit if there is sufficient room to accommodate this.

shielding from stray light can be a major problem when discrete LEDs are used. The layout of the coding disc is shown in figure 5, and also (full size) on the layout pages at the centre of this issue. A disc is made up with either the shape of figure 5a or 5b. If reflection sensors are used then 5a is needed, otherwise 5b is used with LEDs mounted above the disc and phototransistors below them on the printed board. The two pick-up boards are cut into a circular disc shape and the components can then be mounted. Capacitor C3 must be soldered to the track

side of the board, ideally with some form of insulation between it and the copper. Six points on the two boards (P0, P1, P2, P3, +8 V and 1) must be connected by means of wires or some ribbon cable. The boards can then be fixed together 'sandwich fashion' held in place by a 5 mm diameter rod that is fixed to the base of the 'transmitter' casing. The coding disc is fitted in such a way that it is allowed to rotate freely about 1 mm above the reflection sensors. A further plastic disc with two strong magnets glued diametrically opposite each other

Figure 5. The layout for the coding disc (shown here half size). Possibly the easiest way to make this disc is to cut the required shape from a piece of printed circuit board material with a fret saw. Figure 5a is the design to use with reflection sensors, and figure 5b with LEDs above the disc and phototransistors below. They are also shown full-size on page 1-45.

5



84001-5b

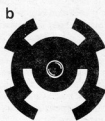

84001-5a

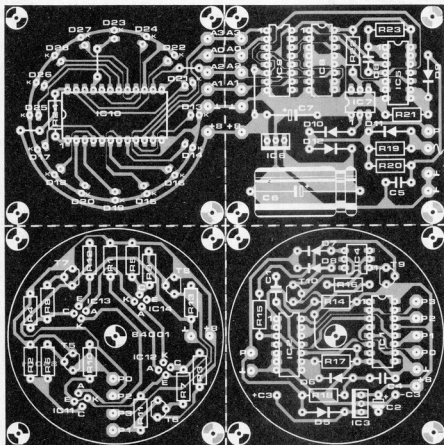

is fixed above the coding disc such that the two discs rotate together. The whole construction must fit into the (inverted) transparent jar so that the disc with the magnets can rotate freely. The connecting cable is passed through a hole drilled in the lid and soldered to the lower printed circuit board. The opening is then sealed well. The form of construction is illustrated in figure 6 but, as usual, individual ideas will probably change this significantly.

Now all the electronics is protected in a watertight package, but, if the light sensitive components are not to be affected by ambient light, it must also be made light-proof. This can easily be done by painting the outside of the jar black.

Looking at the mechanical construction it is obvious why again we recommend using reflection sensors if possible. If LEDs and photo transistors are used the LEDs must somehow be fixed above the coding disc and they must also be provided with their own power supply.

The construction of the outer casing is very dependent upon what material is available. It could, for example, be made using PVC tubing. This outer casing ideally should have bearings for the shaft of the wind vane and some sort of cap is needed

to prevent rainwater from getting at these bearings. Remember to provide a hole at the bottom of the casing to prevent condensation building up.

Another plastic disc (or simply a strip of plastic) with two strong magnets is mounted at the lower end of the wind vane shaft. Be sure to get the 'polarity' of the magnets correct as their purpose is to induce the magnets inside the jar to rotate 'in sympathy' with them.

It may be necessary to experiment with the value of resistor R1. In reflection sensors the sensitivity is often so good that the current through the LEDs can easily be reduced and so help to prevent 'false' reflections. With normal LEDs the current could be increased a little. Trial and error is probably the best method to use here until a value is found that enables all wind directions to be correctly indicated.

Constructing the read-out is very straightforward. Depending on the case used, the two boards can either be left joined or separated, but in this latter case points A0...A3, +8 V and I must be linked on both boards. To keep this section as small as possible the two boards can again be mounted sandwich fashion.

The transformer is connected to the read-out

Parts list

Resistors:

R1 = 1k5 1/8 W (see text)
 R2...R9 = 100 k 1/8 W
 R10...R13 = 10 k 1/8 W
 R14, R23 = 56 k
 R15 = 22 k
 R16, R19 = 1 k
 R17, R21, R22 = 10 k
 R18, R20 = 6k8
 R24 = 270 Ω

Capacitors:

C1, C4, C5 = 100 n
 C2, C7 = 4 μ 7/16 V
 C3, C6 = 1000 μ /25 V
 C8 = 1 n

Semiconductors:

D1...D4 = LED, see text
 D5, D11, D12 = 1N4001
 D6...D10 = 1N4148
 D13...D28 = LED, red
 T1...T4 = cheap photo transistor, see text
 T5...T10 = BC 557
 IC1 = 4526
 IC2, IC5 = 4093
 IC3, IC6 = 7808
 IC4, IC7 = 4N25, TIL 111
 IC8 = 4029
 IC9 = 4042
 IC10 = 4067
 IC11...IC14 = OPB 706, OPB 710

Miscellaneous:

Tr1 = mains transformer 12 V/1 A
 S1 = double pole mains switch
 F1 = 500 mA fuse with holder

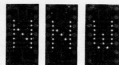
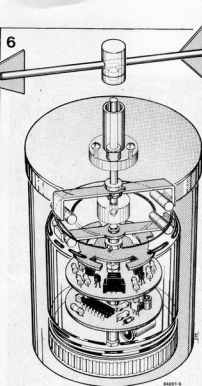

Figure 6. This drawing gives an insight into the mechanical construction of the pick-up section complete with wind vane and 'case'. The electronics are protected from water by sealing them inside a jam jar. Magnetic coupling is used between the wind vane and the coding disc.



section, but if desired it can be moved to some other point on the cable. In this case, of course, D11 and R19 stay with the transformer and are not mounted on the printed circuit board. This unit is then connected to the cable as shown in figure 7. Finally the electronic weathercock must still be calibrated. With the aid of a compass the wind vane is pointed North, and then the whole 'case' is rotated until the read-out shows 'North'. If the pick-up section is already fixed in position on the roof, it could also be calibrated by turning the magnet mounting disc on the shaft of the wind vane.

N S E W

The circuit can be expanded slightly by

Figure 7. The transformer does not necessarily need to be located near the read-out. It can also be connected to the cable somewhere else. If this is done, D11 and R19 stay with the transformer instead of being mounted on the printed circuit board.

7

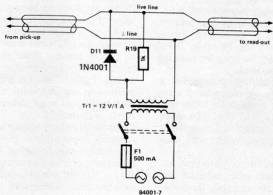

enabling the 16 wind directions to be shown on three dot matrix displays. The circuit for this 'extra' is given in figure 8. This is connected to the data outputs A0...A3 of the read-out section (the outputs of IC9).

The 'data' for driving the displays is contained in a 2 Kbyte EPROM, IC1. The hexdump for the contents of this EPROM is shown in table 1, and this chip is also available from Technomatic Ltd. The displays are multiplexed by counter/oscillator IC3 and 4 to 16 line decoder IC4. The outputs of IC4 drive the 15 LED columns of the displays via transistors T8...T22. The multiplexing frequency is about 3.5 kHz.

The LED rows of the displays are driven by the data outputs D0...D6 of the EPROM. The output signals are amplified by transistors T1...T7, and the current through the LEDs is defined by the values of resistors R3...R9. The maximum current through the LEDs is about 75 mA. This current is needed because each LED is only driven for 1/16 of the time.

The four outputs of IC4 are also connected to the address inputs A0...A3 of IC1, so that when a certain LED column is being driven the appropriate 'switching' data appears at the output. Address inputs A4...A7 receive their data from the latch in the read-out section so that, depending on the wind direction, a specific 16 byte address of the EPROM is selected that contains the information needed to give the correct display. Voltage dividers R12...R15/R16...R19 are included to reduce the 8 V signals of the read-out circuit to the 5 V used by the display. Finally, a link must be connected between pins 12 and 21 of the 2716. This is necessary to select the correct section of the EPROM. The power supply for this section is handled by a separate 5 V stabilizer (IC2). The current consumption of this circuit is about 150 mA.

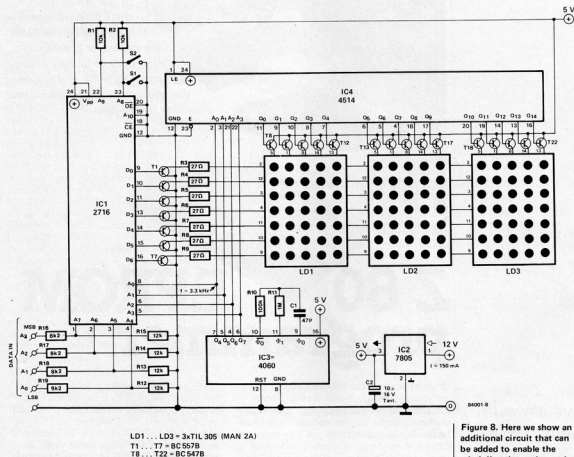

Figure 8. Here we show an additional circuit that can be added to enable the wind direction to be read out on three dot-matrix displays.

```

F00C: 0 1 2 3 4 5 6 7 8 9 A B C D E F
F016: C1 BE BE BE C1 9E AE B6 BA CC C1 BE BE BE C1 FF
F028: 9E AE B6 BA BC 9E AE B6 BA BC C1 BE BE BE C1 FF
F030: 9E AE B6 BA BC C1 BE BE BE C1 FF FF FF FF FF
F040: C0 BF C7 BF C0 9E AE B6 BA CC BF C7 BF C0 FF
F050: 9E AE B6 BA BC C0 BF C7 BF C0 FF FF FF FF FF
F060: FF FF FF FF 9E AE B6 BA BC FF FF FF FF FF
F076: 9E AE B6 BA BC 9E AE B6 BA BC C0 BF C7 BF C0 FF
F080: C1 BE BE BE C1 80 F7 F7 FF C1 BE BE BE C1 FF
F090: C0 BF C7 BF FF C1 BE BE BE C1 FF FF FF FF FF
F0A0: FF FF FF FF 80 F7 F7 FF 80 FF FF FF FF FF
F0B0: C0 BF C7 BF 80 F7 F7 FF 80 C1 BE BE BE C1 FF
F0C0: FF FF FF FF C0 BF C7 BF C0 FF FF FF FF FF
F0D0: C0 BF C7 BF C1 80 FF F7 FF C4 BF C7 BF C0 FF
F0E0: C0 BF C7 BF C0 BF F7 FF 80 C0 BF C7 BF C0 FF
F0F0: 80 F7 F7 FF C0 BF C7 BF C0 FF FF FF FF FF
F100: FF FF FF FF C1 BE BE BE C1 FF FF FF FF FF
F110: C1 BE BE BE C1 D9 B6 B6 BF CD C1 BE BE BE C1 FF
F120: D9 B6 B6 BF CD D9 B6 B6 BF CD C1 BE BE BE C1 FF
F130: D9 B6 B6 BF CD C1 BE BE BE C1 FF FF FF FF FF
F140: C0 BF C7 BF C0 D9 B6 B6 BF CD C0 BF C7 BF C0 FF
F150: D5 B6 B6 BF CD BF C7 BF C0 FF FF FF FF FF
F160: F1 FF FF FF FF D5 B6 B6 BF CD FF FF FF FF FF
F170: D9 B6 B6 BF CD D5 B6 B6 BF CD C0 BF C7 BF C0 FF
F180: C1 BE BE BE C1 80 F7 FF 80 C1 BE BE BE C1 FF
F190: D9 B6 B6 BF CD C1 BE BE BE C1 FF FF FF FF FF
F1A0: FF FF FF FF 80 F7 FF 80 FF FF FF FF FF
F1B0: C0 BF F7 FF 80 F7 FF 80 C1 BE BE BE C1 FF
F1C0: FF FF FF FF C0 BF C7 BF C0 FF FF FF FF FF
F1D0: C0 BF C7 BF C0 BF F7 FF 80 C0 BF C7 BF C0 FF
F1E0: C0 BF F7 FF 80 FF F7 FF 80 C0 BF C7 BF C0 FF
F1F0: 80 F7 F7 FF 80 C0 BF C7 BF C0 FF FF FF FF FF

```

```

F200: FF FF FF FF 80 B6 B6 BF 80 B6 B6 BF FF FF FF FF
F210: C0 BF C7 BF C0 D9 B6 B6 BF CD 80 B6 B6 BF FF
F220: D9 B6 B6 BF CD D5 B6 B6 BF CD C0 BF C7 BF C0 FF
F230: D5 BF 80 B6 BF CD C0 BF C7 BF C0 FF FF FF FF
F240: C0 BF C7 BF C0 D9 B6 B6 BF CD C0 BF C7 BF C0 FF
F250: D9 B6 B6 BF CD C0 BF C7 BF C0 FF FF FF FF FF
F260: FF FF FF FF D9 B6 B6 BF CD FF FF FF FF FF
F270: D9 B6 B6 BF CD D9 B6 B6 BF CD C0 BF C7 BF C0 FF
F280: F0 B6 B6 BF BF C0 BF F7 FF 80 B6 B6 BF BF FF
F290: 80 BF F7 FF 80 B6 B6 BF BF BF FF FF FF FF
F2A0: FF FF FF FF 80 F7 FF 80 F7 FF 80 FF FF FF FF
F2B0: 80 BF F7 FF 80 BF F7 FF 80 B6 B6 BF BF FF
F2C0: FF FF FF FF C0 BF C7 BF C0 BF C0 FF FF FF FF
F2D0: C0 BF C7 BF C0 C0 BF F7 FF 80 C0 BF C7 BF C0 FF
F2E0: 80 BF F7 FF 80 C0 BF C7 BF C0 FF FF FF FF
F2F0: FF FF FF FF 80 B6 B6 BF BF BF FF FF FF FF
F300: FF FF FF FF 80 B6 B6 BF BF BF FF FF FF FF
F310: 80 B6 B6 BF BF D5 B6 B6 BF CD 80 B6 B6 BF BF
F320: D9 B6 B6 BF CD D5 B6 B6 BF CD 80 B6 B6 BF BF
F330: D9 B6 B6 BF CD F4 B6 B6 BF BF FF FF FF FF
F340: C1 BE BE BE C1 D9 B6 B6 BF CD C1 BE BE BE C1 FF
F350: D9 B6 B6 BF CD C1 BE BE BE C1 FF FF FF FF FF
F360: FF FF FF FF D9 B6 B6 BF CD FF FF FF FF FF
F370: D9 B6 B6 BF CD D9 B6 B6 BF CD C1 BE BE BE C1 FF
F380: 80 BF B6 B6 BF 80 BF F7 FF 80 B6 B6 BF BF BF
F390: 80 BF F7 FF 80 B6 B6 BF BF BF FF FF FF FF
F3A0: FF FF FF FF 80 BF F7 FF 80 FF FF FF FF FF
F3B0: 80 BF F7 FF 80 BF F7 FF 80 BF B6 B6 BF BF BF
F3C0: FF FF FF FF C1 BE BE BE C1 FF FF FF FF FF
F3D0: C1 BE BE BE C1 80 BF F7 FF 80 C1 BE BE BE C1 FF
F3E0: 80 BF F7 FF 80 BF F7 FF 80 C1 BE BE BE C1 FF
F3F0: 80 BF F7 FF 80 C1 BE BE BE C1 FF FF FF FF FF
F400:

```

Table 1. Hexdump for the data that must be stored in EPROM IC1.

B. Barink

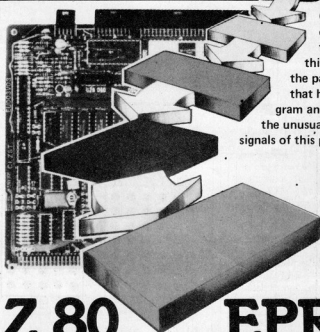

Careful manipulation of the WAIT input of the Z 80 is what enables this little circuit to fulfil the particular conditions that have to be met to program an EPROM *in situ* given the unusual timing of the control signals of this processor.

Z 80 EPROM programmer

any Z 80 system with static RAM can be used to program 2716 EPROMs

In order to program a 2716 EPROM there are several conditions that have to be met. The \overline{OE} (Output Enable) pin must be 'high', the levels on the address and data lines must be stable, the potential on pin V_{pp} must rise from 5 V to the programming voltage of 25 V and finally, the CE (Chip Enable) pin must go 'high' for 50 ms. There is nothing really unusual there but a certain amount of care is needed as the speed of the processor must be slowed down and the peculiarities of the timing of the control signals must be taken into account. It is notable, looking at figure 1, that the \overline{RD} (read) signal appears at the same time as the memory validation signal MREQ (memory request), whereas during a write operation there is a delay of one clock cycle between the appearance of

MREQ and the transition to 'low' of the \overline{WR} signal (write). This is important for us as the programming consists of a prolonged write operation. However, to be able to access the EPROM it must be located somewhere in the addressable area. An address decoding (not represented here) is needed to supply a validation signal for the memory zone occupied by the EPROM.

The circuit and its timing

The address decoding signal must set point 'A' in figure 2 logic 'low'. If this signal has been generated without combining the address lines with the MREQ line, they can still be combined using OR gate N7. If these signals have already been combined, the

Figure 1. This is the timing diagram for the Z 80 control signals during read and write cycles. It is notable that there is a significant time delay between the appearance of MREQ and \overline{WR} , whereas MREQ and \overline{RD} appear simultaneously. A wait circuit is used to set the WAIT line 'low' as soon as the EPROM is addressed, even during a write cycle.

1

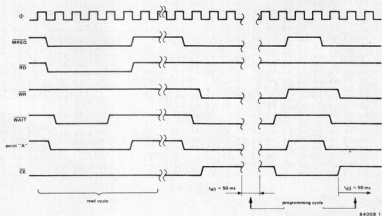

home-made low-cost wiring probe

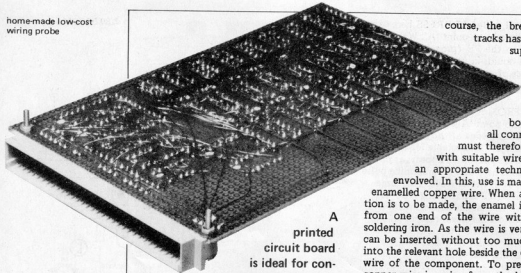

A printed circuit board is ideal for constructing reliable circuits. Not everyone,

however, has the necessary material and tools to produce such boards. Apart from that, it is often not worth the trouble and expense to design, photograph and etch a print layout for one printed circuit board. There are however more ways which lead to Rome.

home-made low-cost wiring probe

time-saving device for the wiring of circuit boards

from a contribution by H. Meßner

There are two main alternative prototyping circuit boards which differ principally in the method of wiring. The first is one with continuous copper tracks: when this is used, only a few additional connections have to be made – provided, of course, that the component layout has been so well thought out that the final product has as few wire connections as possible. Readers who like solving puzzles are well away with these boards! However, particularly in the case of digital circuits, these boards can give problems: depending on the position of IC's, it is often necessary to break the copper track between the connecting pins. Even with the right tools this can prove to be a tiresome and time-consuming job. The second alternative is better suited to such circuits: boards containing only solder pads. Because no account needs to be taken of copper tracks, components can be placed rather more freely on such boards and, of

course, the breaking of tracks has become superfluous. When

this type of board is used, all connections must therefore be made with suitable wire for which an appropriate technique has involved. In this, use is made of thin enamelled copper wire. When a connection is to be made, the enamel is removed from one end of the wire with a hot soldering iron. As the wire is very thin, it can be inserted without too much trouble into the relevant hole beside the connecting wire of the component. To prevent the copper wire jumping from the hole, it is wound several times round the component terminal. In this way it is possible to make multiple connections before they are soldered. The insertion can, of course, be done very well by hand, but there is a simpler way: with a wiring probe. How to make this practical aid is described below.

How to make it

A propelling pencil with a lead diameter of 0.5 mm, a cotton reel and a strip of aluminium (about 90 x 20 mm) are required. If a propelling pencil is not available, take a ball-pen and hypodermic needle (also with an opening of 0.5 mm). Remove the top of the propelling pencil so that it becomes open-ended. When a ball-pen is used, remove the ink reservoir and operating pin or button; the hypodermic needle is then placed in the pen such that it protrudes about 5 mm from the normal writing end. At the centre of the strip of aluminium drill a hole of suitable diameter into which the top end of the pencil or ball-pen is to be inserted.

Two smaller holes are then drilled at either side of, and equidistant to, the centre hole. The aluminium is then bent into a U-shape so that the cotton reel fits between the two vertical sides as shown in figure 1. To ensure that the reel can rotate freely, use a 2 BA screw and nut as spindle. All that remains to be done is to wind a suitable length of enamelled copper wire onto the reel.

Home-constructed circuits should present no problems

Material

Prototyping circuit boards are usually available from an electronics retailer in so-called Eurocard sizes. The most suitable material is epoxy board which is appreciably more stable than pertinax. The wire to be used is common enamelled copper wire of 0.25 . . . 0.35 mm diameter. A special type of wire is available which, although it is a little dearer, is more easily tinned and soldered. Moreover, it is available in different colours, which is useful for complicated circuits. Whatever wire is used, however, there is one golden rule: tin first, solder

afterwards!

Readers who are thinking of using the wire of a transformer or choke will find that the enamel on such wire is very difficult to remove. A further disadvantage is that the enamel has often become so hard that it crumbles during removal of the wire from the transformer or during rewinding onto the cotton reel: the possibility of a short then becomes very real! The most important tool, the soldering iron, is required to have a tip temperature of 350...400 degrees centigrade, otherwise it will not be possible to remove the enamel with it. An iron with adjustable temperature is ideal, but if this is not available, try to remove the enamel with the one that is to hand. More tools are not really required, although a pair of small pliers and a pair of tweezers are very useful.

Preparation and construction

It is advisable at all times (and not just with this method of construction) to use IC sockets, as soldering direct onto IC pins often ruins the component. It may also be worthwhile, especially for beginners, to take sufficient time to consider the best

1

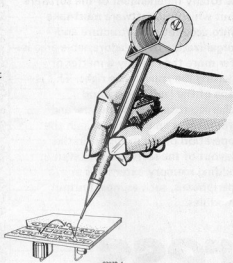

home-made low-cost wiring probe

Figure 1. The ready-made wiring probe. It can be seen clearly how the wiring is carried out with this tool.

2

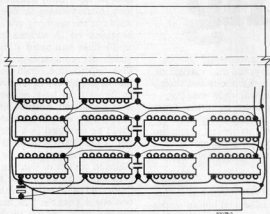

Figure 2. The supply lines should be fitted first. The heavy lines are the 0 V (earth) lines. The thin lines are the connections with the + supply line. The various capacitors between the supply lines are for decoupling.

location for the IC's. A mirror image sketch or drawing of the IC connections obviates a lot of turning over of the board.

First place the socket onto the board and solder the diagonally opposite pins (for instance, the + and - of the IC) to the board. After all other components, screws, pins, and so on, have been placed in their respective positions on the board, a start can be made with the wiring. The supply lines should be done first (see figure 2).

The 0 V (earth) line is best done in bare copper wire and the + line in insulated copper wire, somewhat thicker than is used for the remainder of the connections. In most digital circuits a diameter of 0.4 mm for the supply lines is adequate. A hint: mark pin 1 of all IC's on both sides of the board: this will simplify finding one's way in the tangle of wires appreciably!

With careful work, it is possible to construct even a 16 or 64 k RAM-card in this way, which shows that prototyping circuit boards are not necessarily inferior to printed circuit boards!

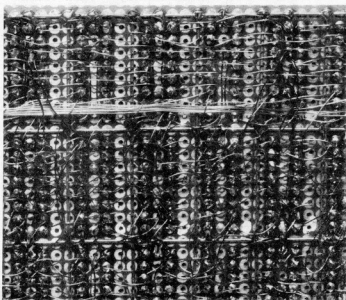

Memory in a computer is a hardware combination of logic elements which is totally independent of the software but which the software must take into account. The structure and organization of the addressable area is far more than simply a matter of getting the appearance right. This is one of the least understood characteristics of computers, and yet it plays an essential role in the operation of the machine, in the layout of the software, and even in adding memory extensions or peripherals, such as input/output modules.

address decoding

why and how an addressable area is organized

The memory of a computer could be compared to a large library: the information, or data if you prefer, is the books and their contents, which we will only mention briefly here. What interests us in this library is its filing system, and especially the way that it is laid out, with its groups, categories, sub-groups and so on. In other words, it is the reference system that we are interested in.

The value of the information

Imagine a catalogue of several billion works dealing with the most varied and different subjects. Our library, of course, contains books on electronics. These are gathered under the reference 'E'. Books about digital electronics are located under the reference of 'ED', whereas those concerning analogue subjects are classified under 'EA'. In data terms we would call the letter 'E' the most significant bit of the references 'ED' and 'EA', and 'D' and 'A' are less significant bits. This distinction is easily seen as the letter 'E' here signifies all works dealing with electronics in our imaginary library, whereas the letters 'D' and 'A' refer only to a certain number of these books. If we continue to make our references even more detailed, the next character (which is less significant again than the previous two) could, for example, be used to distinguish between works in English and those that are not. So a book filed under 'EDE' is in English and deals with digital electronics, while a book with the reference 'EAF' deals with analogue electronics and is written in French. This last character (*English or not*) is less significant than its predecessor (*digital or analogue*): within the category of 'elec-

tronic works', the distinction between 'digital' works and 'analogue' works is more important than between works written in English and those written in French. To finish with this attempt to clarify the idea of the significance (or importance) of information, here is a little example. It has to do with the prices displayed by shopkeepers on their merchandise. They would much rather ask £ 9999.99 than £ 10000.00 for a product. Why is that? The most significant information (the number of thousands of pounds seems cheaper between one price and the other, but in fact the difference is insignificant as it only involves a very slight change in the least significant information character.

Subdivision and double addressing

Let us now turn to computer memories. These appear as a stack of compartments (called memory cells), each containing 8 irreducible units in the systems most familiar to us, that is 8-bit microcomputers. These discrete units, the bits, are not separately accessible: they constitute an eight-bit word called a byte, and their logic values make up the data. This word travels to the interior of the system via the data bus, which consists of eight lines numbered D7...D0, each corresponding to one data bit. The words in the memory are accessed by the processor via an address bus, consisting of 16 lines numbered A15...A0, along which our compartments are arranged. This organization could be compared to that of the library in the preceding example. In figure 1 we have represented the six least significant address bits (A5...A0) as corridors with successive branches as it could be imagined in a library. Whether a left or right turn is taken in these corridors, the end is reached little by little. The decision to go 'left or right' in an address line is indicated by its high or low logic level (indicated as '1' or '0'), which are the only two states possible. The more the binary 'weight' of an address bit is increased, the more important the zone covered by it becomes. Because bits 5 and 4 in figure 1 are both '0', a '0' at bit 3 means that the area from 00 to 07 is selected, whereas if bit 3 is '1' the zone from 08 to 0F is accessed. If bit 4 then changes to '1' with 5 still being '0', the decision of bit 3 selects between zone 10...17 and 18...1F. Assume that in a specific application the logic level of bit 3 is not defined while bits 4 and 5 are both '0', then the result is that the zones mentioned before are no longer differentiated. Zone 00...07 will be confused with zone 08...0F. This is called *double addressing*. Depending on the binary weight of the undefined bit, the range of the doubly addressed zones will be more or less important.

2¹⁶ = 65536

The six most significant address lines are shown in figure 2, which also indicates their contribution to splitting up the addressable area. Quantities indicated by the sign 'K' are always multiples of 1024 (not 1000), which is the number of memory cells ac-

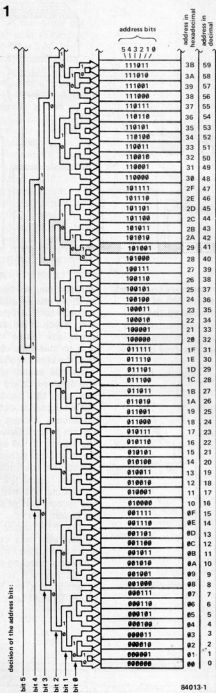

Table 1. Using 16 address lines 65536 words can be addressed. This table shows how the decision of each bit affects which address is to be decoded.

Figure 1. This binary 'tree' of the six least significant bits of an address shows how the decision of a bit (high or low logic level) determines the decoding of a zone whose size depends on the binary 'weight' of the bit.

cessible with the first ten address lines (A9...A0; $2^{10} = 1024$). Consequently, when talking about memory, the sign 'K' designates 1024 bytes and not 1024 bits. Depending on whether address line A15 is at a high or low logic level, one of the two 32768-word halves of the total memory addressable with 16 lines ($2^{16} = 65536$) is selected. Within each of these blocks, line A14 differentiates between two blocks of 16384 words... and so on until line A10 which allows two blocks of 1024 words to be selected within a block of 2048 words decoded by A11. As we mentioned before, if the logic level of one of the address lines

Table 1.

ADDRESSES	01010	01011	01100	01101	01110	01111
DEC. HEX						
0 0000	0000	0000	0000	0000	0000	0000
15 000F	0000	0000	0000	0000	0001	0001
16 0010	0000	0000	0000	0001	0000	0000
31 001F	0000	0000	0001	0001	0001	0001
32 0020	0000	0000	0000	0010	0000	0000
63 003F	0000	0000	0000	0010	0001	0001
64 0040	0000	0000	0000	0011	0000	0000
127 007F	0000	0000	0001	0011	0001	0001
128 0080	0000	0000	0000	0100	0000	0000
255 00FF	0000	0000	0000	0100	0001	0001
256 0100	0000	0001	0000	0000	0000	0000
511 01FF	0000	0001	0000	0001	0000	0000
512 0200	0000	0000	0000	0000	0000	0000
1023 03FF	0000	0001	0000	0001	0001	0001
1K → 1024 0400	0000	0000	0000	0000	0000	0000
2047 07FF	0000	0000	0000	0001	0000	0000
2048 0800	0000	0000	0000	0000	0000	0000
4095 0FFF	0000	0000	0000	0001	0001	0001
4096 1000	0000	0001	0000	0000	0000	0000
8191 1FFF	0000	0001	0000	0001	0000	0000
8192 2000	0000	0000	0000	0000	0000	0000
16383 3FFF	0000	0001	0000	0001	0001	0001
16384 4000	0000	0000	0000	0000	0000	0000
32767 7FFF	0000	0001	0000	0001	0001	0001
32768 8000	0000	0000	0000	0000	0000	0000
65535 FFFF	0000	0001	0001	0001	0001	0001

is undefined two normally distinct blocks are confused. So if the logic level of A15 is not specified, address 0 and address 32768 are mixed up. The same applies for address 1 and address 32769, and so on. Don't forget that for addressing, no matter what the base (binary, decimal or hexadecimal), the count always starts from 0. This leads us to table 1, which shows the 16 address lines, their 65536 possible combinations and the corresponding addresses. Despite the apparent linearity of the progression of this table, the weight of the address lines increases from right to left, and in line with this increase the range of the zones covered by the decision of an address bit becomes more important. This is shown at the extreme left of the table where the ranges of the zones decoded are indicated.

Generating enable signals

So far we have considered the problem of addressing purely as a matter of topography. Looking at the integrated circuits that we must manipulate, we see that the most common ones do not have 16 address lines but a lesser number, proportional to their capacity. As can be deduced from figure 2, a chip containing 4 K (such as a 2732 EPROM) must have 12 address lines (A11...A0). Addressing each of the 4096 words is achieved by means of an internal address decoder incorporated in the IC. In the same way an IC containing 2 K of memory (for example the still common 6116 RAM) will have 11 address lines (A10...A0) which will enable the internal decoder to distinguish between the 2048 memory cells. What is called address decoding is not, strictly speaking, this internal

Figure 2. The levels of the most significant bits determine how the addressable area is broken up into blocks that fit inside one another. So, line A15 distinguishes two blocks of 32 K inside each of which A14 can select between two 16 K blocks, and so on.

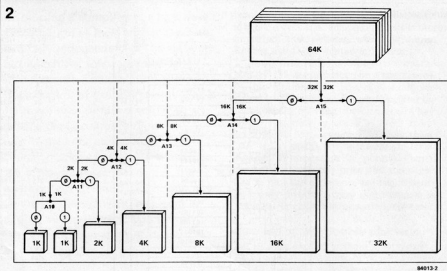

decoding in the block of memory contained in an IC, but rather the location of this block in the area addressable by the CPU. For our examples we will concentrate on the 6502 and Z80, both of which have 16 address lines and can therefore decode up to 64 K of memory. Every memory IC has, in addition to the

address lines we have just mentioned, one or more enable inputs. These have to be brought to a certain logic level (generally low, which is indicated by a negation bar above the 'name' of the corresponding pin) to make the chip active. This means that the internal addressing only takes place when the enable signal is present, and the data words are not placed on the data bus until this condition is fulfilled. This enable signal is obtained using the most significant address lines, combined with certain control signals that are essential for the timing of the operations (see figure 3). These control signals are different for each system; for the 6502 they are:

- clock signal $\Phi 2$ which only permits reading and writing operations during the second half of each clock cycle of the processor, and
 - the R/ \bar{W} signal which distinguishes between read operations (Read) and write operations (Write).
- The corresponding signals in the Z80 are:
- WE and RE to distinguish between writing (Write Enable) and reading (Read Enable), and

Figure 3. The data and address buses are not all that is needed for addressing the memory; a certain number of control signals are also essential to ensure the correct timing of the read and write operations.

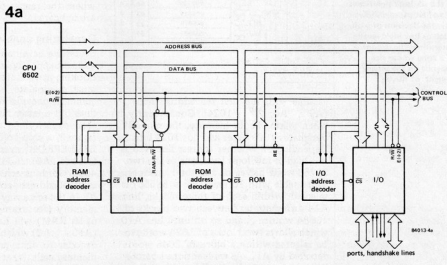
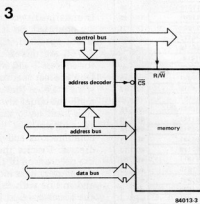
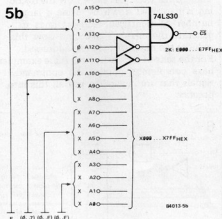
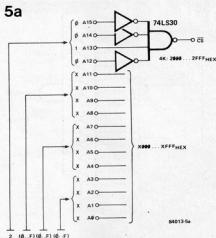

Figure 4a. The 6502 has no specific instructions or signals to distinguish the memory from the input/output modules. The control signals needed to enable the operations are clock $\Phi 2$ and the read/write (R/ \bar{W}) signal.

■ **MREQ** and **IOREQ** to distinguish between operations carried out with the memory and those dealing with the input/output module for which the Z80 has specific instructions. The differences between the two processors are clarified by figures 4a and 4b. The validation signals, obtained from the most significant address signals and the control signals, are all referred to here as **CS** (Chip Select). Just for the sake of making things easier to follow, we will assume that they are always active at the low logic level. However, depending on the system and the manufacturer, it is possible to find some signals, including the enable signal, which are active high. Before getting on to the logic combinations which will allow these enable signals to be generated it is no harm to emphasize the importance of the hexadecimal base. We have sixteen address lines grouped as 4 x 4 lines. There is a hexadecimal figure (0...F; 0...15 in decimal) corresponding to each group of four lines. In address 4A2F, for example, the 4 corresponds to the binary word for lines A15, A14, A13 and A12 (0100), the A corresponds to the binary word on lines A11, A10, A9 and A8 (1010), the 2 to the word on lines A7, A6, A5 and A4 (0010) and the F to that on A3, A2, A1 and A0 (1111). This simple conversion allows the configuration of the 16 address lines, corresponding to an address given in hexadecimal, to be easily found.

Fixed logic combinations

Now we will start looking at the address decoding proper, achieved by means of more or less complex logic combinations. Imagine a memory circuit to be enabled between addresses 2000 and 2FFF. Lines A11...A0 decode 4096 memory cells between X000 and XFFF. Combining the A15...A12 lines as shown in figure 5a provides a **CS** signal active (at logic zero) only when the configuration of the lines is '0010', that is the number 2. The example of figure 5b shows more precise decoding. The enable signal **CS**, obtained by combining lines A15...A11 logically, is only active when the configuration of



these lines gives the values E0...E7. The other address lines allow each of the 2048 addresses between E000 and E7FF to be addressed. The decoding obtained with the combination shown in figure 5c is even more precise: **CS** is only at logic zero when A3...A15 give the hexadecimal value C10; while the three remaining lines are used for addressing the eight bytes between C100 and C107.

address decoding

Figure 5a & 5b. Examples of fixed address decoding, of 4 K and 2 K bytes. As the zone addressed becomes smaller, so the number of address signals combined becomes larger.

4b

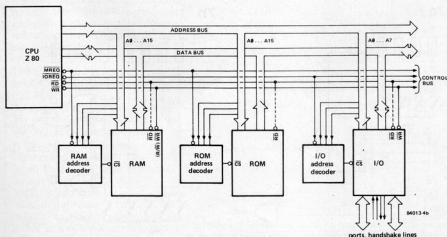
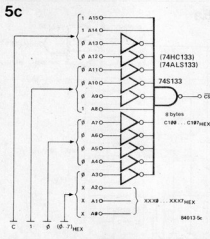

Figure 4b. The internal structure of a Z80 system is quite similar to that of a 6502, except that it has more (and more specific) control signals. It is beyond the scope of this article to discuss the problems associated with timing these signals.

Figure 5c. Another example of fixed address decoding, in this case 8 bytes are decoded.



These three examples show how the decoding is narrowed down by using a larger number of significant address lines to generate the enable signal, and how this reduces the range of the zone addressed. For the sake of simplification, these examples have completely ignored the command signals that are needed to put all this into practice.

Figure 6. The 74LS138 decoder allows an 8 K block (decoded using A13...A15) to be easily split up into blocks of 1 K, each with its own CS signal. The second enable input is treated differently depending on whether it is used with the Z 80 or the 6502.

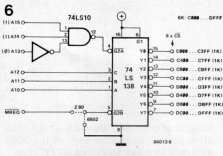

A multiple address decoding circuit is shown in figure 6. It contains a commonly used decoder IC, the 74LS138, which has three binary data inputs and two enable inputs ($G2A$, $G2B$). Signal $G2A$, which is obtained from a combination of A13...A15, is only active between C000 and DFFF, a block of 8 K. Input $G2B$ picks up the

$MREQ$ signal from a Z 80, or is tied to earth (logic zero) if used with a 6502 processor. The three bit binary word created by combining A10...A12 allows eight successive blocks of 1 K to be decoded. The eight CS signals thus produced could be applied to the memory, in conjunction with command signals WE, RD or R/W.

Variable logic combinations

The decoding examples examined so far have one thing in common, that they are invariable, but variable address decoding is also possible, as illustrated by figure 7. The main part of this diagram is the four bit magnitude comparator, a 74LS85. A binary word A0...A3 is provided by address lines A12...A15. This is compared by the 74LS85 with the binary word supplied by four switches connected to earth and four polarizing resistors to the high logic level. When binary word A0...A3 is the same as binary word B0...B3 pin 3 (A = B) goes logic high. The output of this pin is then inverted and becomes the CS signal for a 4 K memory block (X000...XFFF, where X is the hexadecimal value corresponding to binary word B0...B3).

The same sort of programmable address decoding could be achieved using EXNOR gates, as shown in figure 7b. The open collector outputs of the 74LS266 are all logic high only when the two inputs of each gate are at the same logic level. Each gate compares one bit of the address word formed by A12...A15 with the corresponding bit of the binary word programmed using the switches and polarizing resistors. This procedure has the advantage that it adds flexibility to the address decoding. Furthermore, as the dotted lines of figure 7b suggest, it is quite easy to narrow the programmable decoding by increasing the number of significant address lines used, and thus reducing the range of the block enabled by the CS signal. With that we will finish this article on address decoding, and, while we realize that there is much that has not been said about the subject, we hope that at least some light has been thrown on the address bus and how it works.

Figure 7. In certain applications it is desirable to have programmable, or at least variable, addressing. This is achieved using a magnitude comparator that determines when the binary word formed by lines A12...A15 is the same as the word formed by the user with the four switches. An alternative is to use EXNOR gates, as shown in b. The outputs of the 74LS266 are all high only when the two inputs of each gate are at the same logic level.

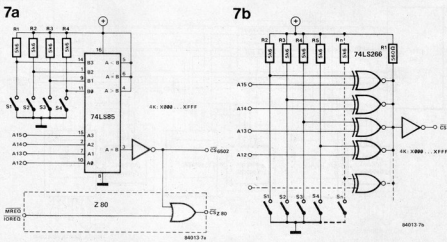

programmable crystal oscillator

Programmable crystal oscillators (PXOs) are not new. They normally consist of a discrete stabilized oscillator, quartz crystal, and one or more dividers which are controlled by logic levels. What is new about the range of PXOs recently introduced by Statek Corporation, one of the largest oscillator manufacturers in the USA, is that the oscillator, dividers, and selector circuits are constructed as a CMOS-IC which is housed together with the quartz crystal in a standard 16-pin DIL package.

Statek has already brought eight of these PXO units onto the market: the only difference between them is the fundamental quartz frequency. This frequency is indicated by the number in the type-coding on the unit: for instance, in a PXO-600 it is 600 kHz. Standard crystal frequencies at this moment are: 192 kHz, 327.68 kHz, 600 kHz, 768 kHz, 983 kHz, 1 MHz, 1.3 MHz, 1.6 MHz, and 1.97 MHz. Statek can meet individual customer's requirements for non-standard frequencies.

The internal construction and pin-out are shown in figure 1. The direct output of the internal oscillator (OSC) is amplified and then available at pin 11 (F_{OUT}). The oscillator is also connected to the selection logic (SEL) which is controlled from pin 13 (CSEL). When this pin is logic high (TTL-level), the selector connects an external clock (EXC - pin 12) instead of the internal oscillator to the first divider.

The divide ratios of the two dividers are determined by three inputs each (PROG 1...3 and 4...6 respectively): table 1 correlates the inputs and the ratios. A little arithmetic will show that 57 different frequencies are available from a single crystal.

The output of the second divider is amplified and then available at pin 9 (OUT).

A logic 0 at the RESET input (pin 14) sets the dividers to 1/1 and the OUTput (pin 9) to logic low.

A somewhat unfortunate designation has been given to pin 10: TEST. When this pin is logic high, the output frequency is multiplied by 1000, provided the overall divide ratio is not lower than 1/1000.

Internal pull-down resistors in the dividers, and a pull-up resistor in the reset circuit, ensure a non-

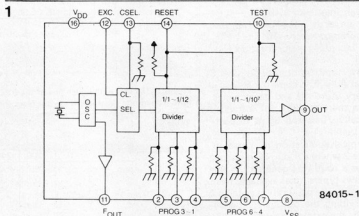
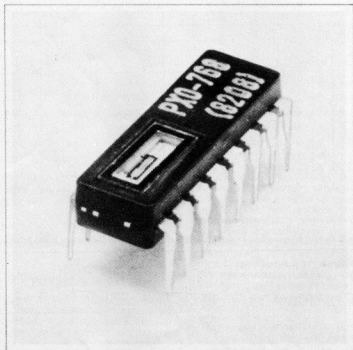

Figure 1. Block schematic and pin-out of a programmable crystal oscillator (pins 1 and 15 not used).

Table 1

Prog 1	Prog 2	Prog 3	Divide ratio	Prog 4	Prog 5	Prog 6	Divide ratio
0	0	0	1/1	0	0	0	1/1
0	0	1	1/10	0	0	1	1/10
0	1	0	1/2	0	1	0	1/10 ²
0	1	1	1/3	0	1	1	1/10 ³
1	0	0	1/4	1	0	0	1/10 ⁴
1	0	1	1/5	1	0	1	1/10 ⁵
1	1	0	1/6	1	1	0	1/10 ⁶
1	1	1	1/12	1	1	1	1/10 ⁷

Table 1. The divide ratios of the two dividers can be set independent of one another — note that the program numbers DO NOT coincide with the pin numbers!

aplikator

Table 2

Program pin levels			P4	0	0	0	0	1	1	1	1
			P5	0	0	1	1	0	0	1	1
			P6	0	1	0	1	0	1	0	1
P1	P2	P3									
0	0	0	768k	76.8k	7.68k	768	76.8	7.68	0.768	0.0768	
0	0	1	76.8k	7.68k	768	76.8	7.68	0.687	0.0768	0.00768	
0	1	0	384k	38.4k	3.84k	384	38.4	3.84	0.384	0.0384	
0	1	1	256k	25.6k	2.56k	256	25.6	2.56	0.256	0.0256	
1	0	0	192k	19.2k	1.92k	192	19.2	1.92	0.192	0.0192	
1	0	1	153.6k	15.36k	1.536k	153.6	15.36	1.536	0.1536	0.01536	
1	1	0	128k	12.8k	1.28k	128	12.8	1.28	0.128	0.0128	
1	1	1	64k	6.4k	640	64	6.4	0.64	0.064	0.0064	

*33% duty cycle **40% duty cycle

Table 2. Output frequencies of the PXO-768 model for various logic levels at the PROGRAM pins (Unit shown: Hz.)

ambiguous logic level, even if the relevant pins are not connected. Pins 1 and 15 are not used.

Other important technical parameters are:

- high calibration tolerance – standard ± 100 ppm
- low ageing – maximum 10 ppm in first 12 months
- high frequency stability – maximum drift $\pm 0.015\%$ over the temperature range $-10^{\circ}\text{C} \dots +75^{\circ}\text{C}$ (not including the calibration tolerance)
- low current consumption (CMOS), yet fully TTL compatible
- very short rise and decay times (in the PXO-600, for instance, typically 70 ns and 30 ns respectively)

A typical application is shown in figure 2 where a PXO-768 is connected as a baud rate generator. Table 2 shows typical rates available from this unit. The baud rate is obtained by dividing the output frequency by 16: the extreme values of 0.0004 and 48,000 baud/sec are, of course, hardly ever used. It is, unfortunately, not possible to obtain all baud rates encountered in practice from each PXO unit: a rate of 75, for instance, cannot be derived from a PXO-768 (although it can from a PXO-600). The PXOs can also be used for a variety of other applications, such as a square-wave generator, a rectangular-wave generator with variable duty-cycle, or a monostable multivibrator.

2

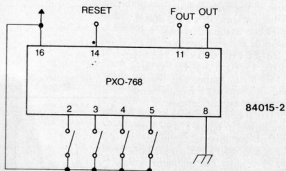

Figure 2. The ease with which one of the PXOs and a four-way DIL switch can form a baud rate generator is evident from this diagram.

Table 3

Output freq. kHz	19.2	38.4	76.8	153.6	768
Baud rate	1200	2400	4800	9600	48000
Pin 2	0	0	1	1	0
Pin 3	0	1	0	0	0
Pin 4	1	0	0	1	0
Pin 5	1	1	0	0	0

Table 3. Some baud rates – in baud per second – available from the generator in figure 2.



Further information from:
I.Q.D. Limited
29 Market Street
Crewkerne
Somerset
TA18 7JU
Telephone: (0450)74433

Literature: Statek Corporation data sheet 'Programmable Crystal Oscillator'

ACTUAL SIZE

MINI PCB CONNECTOR

Om Lila's, Bombay, have introduced mini PCB connectors used in colour and B/W TV's, tape recorders, electronic instruments, computers, etc. Range of availability is: 1 to 8 pin & 10, 12, 14, 16, 18, 20 & 22 pin. The male part is directly soldered onto the PCB and wires on the female part of the connector are soldered. Wire connections can be easily connected/disconnected during servicing or testing.

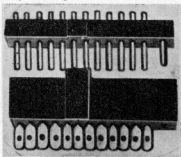

OM LILA'S
Plot No. 84-A/B
Govt. Ind. Estate
Kandivlee (W)
Bombay - 400 067.

DIL COMPONENT CARRIERS

These carriers are ideal for mounting discrete components to form a plug-in modular circuit. The contacts are IC spaced i.e. 2.54 mm between contacts and 5.08 mm between the two rows of contacts.

The body is moulded from glass filled nylon to withstand soldering temperatures. Top covers are available for 8, 14 and 16 pin carriers.

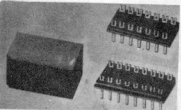

For further details write to
Instrument Control Devices,
14, Manorama Niwas,
Datar Colony,
Bhandup,
Bombay - 400 078. (INDIA).

COOLING FAN

The Electra fan can be used to cool a wide range of instruments and equipment, viz. computers, power supplies, copying machines, medical instruments, etc.

The manufacturers claim that it is very rugged and reliable with a long life trouble free motor and silent polycarbonate blade.

The usual model operates on 230 VAC. Models for other voltages can be made available.

Power consumption is 25 VA with a 90 CFM delivery.

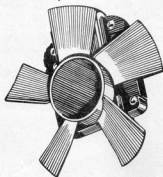

Please write to
ELECTRA
Gopi Building,
Behind Vivek Appt.,
Dandia Bazar,
Baroda 390 001.

TITRATION POTENTIOMETER

Rashmi Electronics have developed a titration potentiometer, useful in chemical, pharmaceutical, sugar and distilleries for neutralisation, oxidation, reduction, complex formation, etc. Range: 0-400 mV continuously variable, calibrated dial with a six-position switch extending the range in steps of 400 mV to total 2.4 V. Operates on 230 V, AC.



For further information, contact
Rashmi Electronics
2-15-34, Kadrabad, (Polas Lane
Corner)
Jalna 431 203

MINIATURE RELAY

Electronic Relays (India) Pvt. Ltd., have introduced a miniature type dual in line solid state relay in Dip configuration compatible with standard IC bases. The relay offers photoisolation between input and output terminals with inputs compatible to TTL sources. The manufacturers state that it has high noise immunity, vibration and dust immunity as it is completely potted in a special potting compound. Overall size: 19 mm x 12 mm x 11 mm. Available in two types: DC/DC relay-handling DC load up to 0.5A/40,60,80V and DC/AC relay-handling AC load upto 0.5A/220, 330V.

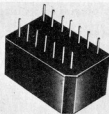

For more details, write to
Electronic Relays (India) Pvt. Ltd.
10/2, Lalbagh Road, Richmond Circle
Bangalore 560 027

DIP EXTRACTOR

Instrument Control Devices have introduced a dip extractor with which ICs and similar devices can be safely removed from their sockets. Also useful in removing or handling components like transistors, capacitors, resistors and hardware, etc., the extractor is particularly useful in high density packaging situation, according to the manufacturers. It is made of one piece spring steel; a lock-nut adjusts movement and controls pressure. The top portion of the device is insulated to prevent electric shocks.

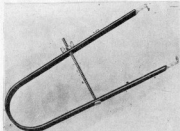

More particulars from
Instrument Control Devices
14 Manorama Niwas, Datar Colony
Bhandup, Bombay 400 078

TWILIGHT SWITCH

Barathronics manufacture a twilight switch which can switch on/off any electrical load, working on mains 230 V, 50 Hz, up to 500 W. Suggested uses: domestic, remote control, street lighting, counting machines, etc. Specifications are:

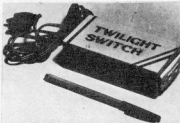

For more details, write to
Barathronics
53, Temple Street, Malleswaram
Bangalore 560 003

PCB Stripboard and Cutter

Fiji Electronics have placed on the market a general purpose PCB stripboard and cutter to help wire circuits conveniently. Two types of stripboards are currently offered: with 0.15 in pitch suitable for circuits using discrete devices and with 0.1 in pitch for circuits using DIL type ICs as also discrete devices.

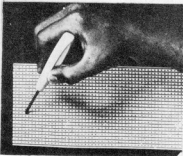

For further details, write to

Fiji Electronics
Mail Order Sales (PCB)
Puthencurichy, Trivandrum 695 303

NUMERIC PRINTER

Process & Control Elements offer a numeric printer, PACE NU-18, which accepts BCD data and gives a print out. It prints 18 columns, 15/16 of which are numerals and 3/2 symbols depending upon user applications. Symbols can be used to identify the variables. Applications: Printing DPMs; Multipoint digital scanner/recorder; El cheapo data loggers; ticketing machines; cash registers.

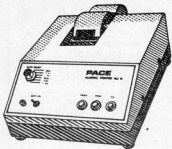

Further details can be had from

Process & Control Elements
111-A, Hind Saurashtra Ind. Estate
Antheri-Kurla Road, Marol Naka
Antheri. Bombay 400 059

EXPLOSION PROOF SWITCHES

Burgess Micro Switch Co. Ltd., of UK have introduced a stainless steel version of explosion proof switches with aluminium castings. Main features are: resistance to corrosion from sea water and immunity from incandescent sparking. The manufacturers recommend its use in marine applications

such as oil rigs and their supply vessels as well as in the petrochemicals industry. The switch has a maximum electrical rating of 15A 480 VAC. Specifications conform to BS 4683, Part 4 and SFA3909. The switches can be imported against actual user's import licence.

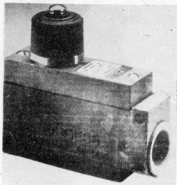

Further information from

Just's Engineering Co. Ltd.
60, Sir Phirozshah Mehta Road
Bombay 400 001

LED HOLDERS

Jain Electronics have developed LED holders in a wide range for 5 mm and 3 mm LEDs. Made in brass and chrome-plated, they are available in reflector type, both round and squares as also LH-43 and LH-49 dome type, as well as in other specifications.

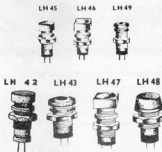

For details, contact

Jain Electronics
F-37, Nand Dham Industrial Estate
Marol, Bombay 400 059

UNIVERSAL MICROCOMPUTER DEVELOPMENT SYSTEM

From Philips comes the Universal Microcomputer Development System type PM 4422, designed as an effective aid in the software design of

microprocessor or microprocessor-based systems in laboratories or industry. The tool can be used for the development and debugging of the hardware and software of the system and later in the phase of system integration. Its modular configuration allows upto 7 users to develop software and test hardware/software integration simultaneously. Demands of memory capacity are met by the built-in Winchester drive with upto 20M byte capacity. Add-on disc extension units allow bulk memory to be increased upto 147M bytes on line.



For further particulars, contact

Peico Electronics & Electricals Ltd.
(Corporate Relations), Band Box
Building, 254-D, Dr. Annie Besant Road,
Bombay 400 025

DIGITAL OHMMETER

Thermal Sensors have designed a compact digital ohmmeter. Salient features of the device are: resistance readings to accuracies of $\pm 0.1\%$ of F.S.D. taken in seconds; compact (6" x 2" x 3 1/2"); lightweight (600 gms); elimination of high battery consumption by use of liquid crystal display; readings can be taken from a distance of 20 feet. For long-term accuracy, self test feature is provided.



More particulars can be had from.

Thermal Sensors
37A, Electronics Complex, Kusaigauda
Hyderabad 500 762

Cotswold Electronics are a new entry in the latest "Concise Edition of The Electronics Book 1983" from STC Electronic Services. These low-noise transformers, all of which have single hole fixing using a dished washer, can be supplied in power-ratings including: 30, 60, 100, 160 and 530 VA.

The toroids have two separate primary windings for parallel 120 V operation or series connection for 240 V operation. Twin separate secondary windings provide a range of output voltages including: 2 x 6, 9, 12, 15, 18, 22, 25, 30, 35, 45 and 50 V r.m.s., depending on the VA size selected. The winding termination is via 150 mm long flexible leads.

The transformers are constructed to materials standards as used in professional

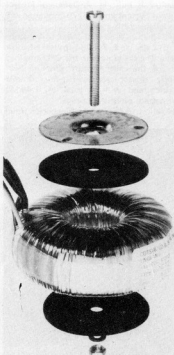

(2831 M)

electronics in avionics, telecommunications and electro-medical etc., including primary to secondary winding insulation to Class E (120°C); winding wire to Class A (105°C) and P.V.C. high temperature grade Class A (105°C). The construction enables these toroids to be operated for short periods at 120°C without deterioration. The transformers can also be operated in a "derated" condition at lower temperature rise and improved regulation. The nominal frequency is 50 to 60 Hz with an operating range of 47 to 400 Hz and the secondary voltage tolerance is within 3% at nominal input and full load.

Cotswold Electronics Ltd.,
Unit T.1.,
Kingsville Road,
Kingsditch Trading Estate,
Cheltenham, GL51 9NX
Telephone: 0242 41313

(2836 M)



Fast C-meter

The newly released CM 200 from Thurby Electronics Ltd is a digital capacitance meter which has a maximum delay between connecting a capacitor and getting the first valid reading of less than half a second. This rapid settling combined with a reading update rate of 3 per second makes the meter unusually fast to use.

The meter has a 4½ digit liquid crystal display with a maximum reading in excess of 25,000 counts. It measures capacitance between 1 pF and 2,500 μF to an accuracy of 0.2%.

Very low power consumption enables the instrument to operate for several hundred hours from batteries. Alternatively it can be operated from the AC line adaptor supplied with it. The CM 200 is housed in a rugged bench/portable case with built-in tilt stand and is lightweight and fully portable for field use.

A special input socket arrangement allows for the direct connection of a wide variety of standard test leads. A zero calibration control enables the user to null out up to 25 pF of test lead capacitance.

Thurby Electronics Ltd.,
New Road,
St. Ives,
Cambridgeshire,
Telephone: 0480 63570

(2838 M)

4½ Digit LCD DPM

A new LCD DPM now available from Lascar Electronics is claimed to offer levels of performance never previously available in a compact module.

The DPM 60 features auto-zero, auto-polarity, and a logic switched 200 mV or 2 V f.s.d., giving a resolution of 10 μV. Other features include programmable decimal points, digital hold, 'low battery' indication, 'continuity' indication and a 10 mm 4½ digit high contrast LCD read out.



The unit can be readily scaled by user to indicate amps, volts, ohms and many other engineering units. Supplied complete with mounting bezel, clips and connector, it will suit many applications calling for low-cost, high accuracy measurement in portable instruments.

Specifications DPM 60

Accuracy 0.01% ± 1 digit
Linearity ± 1 digit
Samples/Sec 1.6
Temp. Stability 50 ppm/°C typ.
Temp. Range 0-35°C
Supply Voltage 7.5 - 15 V
Supply Current 1 mA typ.
Max d.c. input Voltage ± 20 V
Lascar Electronics Limited,
Module House,
Whiteparish, Salisbury,
Wiltshire, SP5 2SJ
Telephone: 079 48 567

(2831 M)

Windspeed sensor

The windspeed sensor from Enterprise A/V Productions has a polyester resin-moulded stator with integral reed switch. The rotor is a two-part device. The spinner is a black polyester resin moulding machined to accept a sealed stainless steel roller bearing. The magnet is of isotropic ferrite press-fitted into the rotor. The wind cups are black plastic mouldings and are a press-fit in the rotor. The windspeed sensor gives 1 pulse per revolution with a 50 per cent duty cycle, and will operate in winds from 0.5 MPH to 100 MPH. The unit has been wind-tunnel tested at 100 MPH. Mounting is by means of a single 0 BA brass stud. The price is £14.95 (ex. VAT) plus p & p.

Enterprise A/V Productions,
Manor Farm 'C',
Grendon Underwood,
Aylesbury,
Bucks,
HP18 0SU
Telephone: 029 677503

(2832 M)

Toroids from STC

Twenty-one toroidal transformers from the "Budget Range" manufactured by

State-of-the-art 16-bit micro

The Duet-16 an advanced new 16-bit microcomputer with a wealth of benefits for the technical and scientific user. Independent benchmark tests show its price/performance ratio to be better than any other micro in its class.

Heart of the system is a powerful 16-bit 8086 processor (which runs at a fast 8 MHz+) with a facility for an 8087 maths code processor. The operating system is MS-DOS, with CP/M-86 coming soon. Languages currently available are Basic-86 (supplied with the system), Advanced Basic and Cobol. Fortran 77 and Pascal are due out shortly.

Other developments are in the pipeline: a Unix facility will enable up to seven people to plug into the Duet-16 processor — all the multi-user, multi-tasking circuitry is built in. A Database, Project Control System and 1-3270 Emulator will be available within weeks.

Duet-16 has a user-expandable memory to 512 Kb and 728064 bytes of disk space. The file storage in the CPU employs two of the new Shugart slim-line 5¼" floppy drives, double density, double tracking and with a total of 1.44 Mb (formatted) on-board storage.

Ten and 16 Mb 5¼" Winchester mini

disk drives will be out soon and Duet-16 will accept three of these without any additional interface.

The package also includes a detachable, low-level keyboard incorporating a 10-key numeric pad and several programmable keys. All 98 keys are self repeating. The CPU has two communications ports, a parallel printer port and an IEEE488 port and will communicate with other computers up to and including mainframes, thanks to readily available TSS software.

There is a basic 96 K of colour graphics RAM giving eight colours. Characters may be superimposed on the graphics screen. Colour word processing software will also come onto the market shortly. Duet-16 is eminently suitable for office or home use. The footprint of the CPU is only 16" x 13" and Lambart are currently developing a carry case. The basic unit includes CPU with 128 K RAM and 2 x 720 K floppy drives, 12" amber VDU and keyboard.

Lambart Micro Computers Ltd.,
52 Moorbridge Road,
Maidenhead,
Berks SL6 8BN.
Telephone: 0628 72037/74916

(2802 M)

Security light

Securilite — a new home safety plug-in security light — is being launched on to the UK electrical market by Smiths Industries Environmental Controls Company.



The inexpensive plug-in security light you can use all round your house whether you are at home or away.

Ideal for children's rooms, hallways, garages — in fact wherever there's a socket. It's economic too. You could run both of these Securilites for 12 hours every day for a year for under 50p.

The new appliance looks similar to a standard 13 amp plug, but contains four neon bulbs which give a soft light as soon as the unit is plugged into a conventional three pin socket. It has been developed as a multi-purpose and economic household safety aid, and has a wide variety of lighting uses.

SI ECC are positioning the Securilite as a cost-effective addition to the home safety market, and believe its versatility and competitive pricing will find favour with consumers. It can be used in a variety of settings, including children's bedrooms, garages and dark hallways — in the home and in the office. The product is extremely economical to run, and can operate for 12 hours a day for less than a penny a week.

Sold on a twin pack blister card the product is the latest addition to the Company's range of plug-in controllers, and SI ECC are anticipating a strong demand for Securilite from both trade and consumer in the winter sales period.

Smiths Industries

(2800 M)



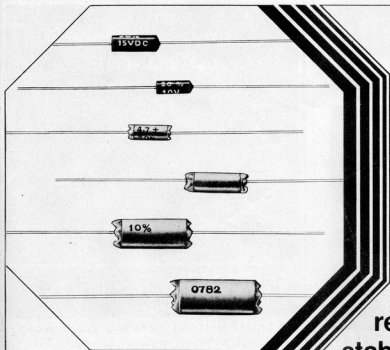

**When
reliability and
stability are your
prime criteria
for selection...**

ECIL's Tantalum Capacitors.

Today sophisticated electronic instruments and circuits require more compact, highly reliable and stable capacitors with a wider temperature range of operation and less parametric changes due to temperature variation.

ECIL's Tantalum Capacitors are designed to meet these exacting standards. Highly reliable, they find application in several areas including:

- ★ Defence equipment
- ★ Computers
- ★ Professional electronic equipment
- ★ On-board space modules
- ★ Process and industrial control equipment

ECIL's Tantalum Capacitor Type HST is approved by LCSO, as per JSS - 50205.



Electronics Corporation of India Limited

(A Govt. of India Enterprise)
Passive Components Marketing
ECIL Post, Hyderabad-500 762

Phone: 852231-258, 852569 Telex: 0155-254
Grams: ECIL HD

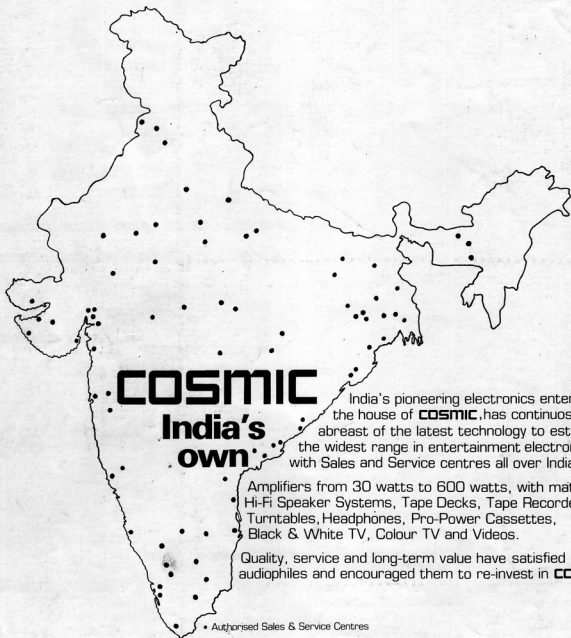

COSMIC

India's own

India's pioneering electronics enterprise, the house of **COSMIC**, has continuously kept abreast of the latest technology to establish the widest range in entertainment electronics with Sales and Service centres all over India.

Amplifiers from 30 watts to 600 watts, with matching Hi-Fi Speaker Systems, Tape Decks, Tape Recorders, Turntables, Headphones, Pro-Power Cassettes, Black & White TV, Colour TV and Videos.

Quality, service and long-term value have satisfied audiophiles and encouraged them to re-invest in **COSMIC**

• Authorised Sales & Service Centres

International quality created for India by **COSMIC**